



Wi-Fi Direct[®] Specification

Version 1.9

WI-FI ALLIANCE PROPRIETARY – SUBJECT TO CHANGE WITHOUT NOTICE

This document may be used with the permission of Wi-Fi Alliance under the terms set forth herein.

By your use of the document, you are agreeing to these terms. Unless this document is clearly designated as an approved specification, this document is a work in process and is not an approved Wi-Fi Alliance specification. This document is subject to revision or removal at any time without notice. Information contained in this document may be used at your sole risk. Wi-Fi Alliance assumes no responsibility for errors or omissions in this document. This copyright permission does not constitute an endorsement of the products or services. Wi-Fi Alliance trademarks and certification marks may not be used unless specifically allowed by Wi-Fi Alliance.

Wi-Fi Alliance has not conducted an independent intellectual property rights ("IPR") review of this document and the information contained herein, and makes no representations or warranties regarding IPR, including without limitation patents, copyrights or trade secret rights. This document may contain inventions for which you must obtain licenses from third parties before making, using or selling the inventions.

Wi-Fi Alliance owns the copyright in this document and reserves all rights therein. A user of this document may duplicate and distribute copies of the document in connection with the authorized uses described herein, provided any duplication in whole or in part includes the copyright notice and the disclaimer text set forth herein. Unless prior written permission has been received from Wi-Fi Alliance, any other use of this document and all other duplication and distribution of this document are prohibited. Unauthorized use, duplication, or distribution is an infringement of Wi-Fi Alliance's copyright.

NO REPRESENTATIONS OR WARRANTIES (WHETHER EXPRESS OR IMPLIED) ARE MADE BY WI-FI ALLIANCE AND WI-FI ALLIANCE IS NOT LIABLE FOR AND HEREBY DISCLAIMS ANY DIRECT, INDIRECT, PUNITIVE, SPECIAL, INCIDENTAL, CONSEQUENTIAL, OR EXEMPLARY DAMAGES ARISING OUT OF OR IN CONNECTION WITH THE USE OF THIS DOCUMENT AND ANY INFORMATION CONTAINED IN THIS DOCUMENT.

Document revision history

Version	Date	Status	Comments
1.0	2009-12-09	Approved for Internal Release	Peer-to-Peer Technical Specification v1.00
1.1	2010-10-04	Final	Public release version
1.2	2011-12-14	Final	Public release version <ul style="list-style-type: none"> - Incorporated changes in 3.1.2.1.2, 3.1.2.1.3, 3.2.2, 3.3.2.2, 3.3.3.2, 4.1.14, 4.1.16, 4.2.1 (Table 37), 4.2.3 (Table 41) as documented in Draft Errata v0-1 for WiFi P2P Technical Specification v1-1.pdf - Incorporated proposed language for response time requirement addition in 3.1.5.1 and 3.2.3 - Incorporated editorial fix to Appendix C (Figure C12) - Updated WSC Primary Device Type attribute table in Appendix B.2 to incorporate new "tablet" sub category (WSC v2.0.1). - Added Display Service Protocol Type in Table 63
1.3		Draft	Internal draft, not publicly released
1.3.32	2014-01-27	Draft	Draft release version to public <ul style="list-style-type: none"> - Updated to support NFC
1.4	2014-03-21	Final	Public release version <ul style="list-style-type: none"> - Clarifications on NFC sections - Updated to incorporate the Wi-Fi Peer-to-Peer Services Addendum version 0.7 - Minor editorial corrections/clarifications
1.5	2014-08-04	Final	Public release version <ul style="list-style-type: none"> - Editorial updates to clarify references to Wi-Fi Peer-to-Peer Services (P2Ps) Specification
1.6	2016-01-14	Final	Corrected missing reference in section 4.2.11.1
1.7	2016-07-06	Final	Public release version <ul style="list-style-type: none"> - Updated to incorporate operation in the DMG (60 GHz)
1.8	2020-10-25	Final	Public release version <ul style="list-style-type: none"> - Editorial update
1.9	2021-10-25	Final	Public release version <ul style="list-style-type: none"> - Allocate bit 6 in the Device Capability Bitmap field in the P2P Capability attribute to Miracast in 6 GHz - Updated references to 802.11-2020 specification

Table of contents

1	Introduction	13
1.1	Scope.....	13
1.2	References	13
1.3	Definitions	14
1.4	Abbreviations and acronyms.....	17
2	Architectural overview	19
2.1	P2P components	19
2.2	P2P topology	19
2.3	Concurrent operation	21
2.4	Functions and services	22
2.4.1	Basic functions and services.....	22
2.4.2	P2P specific functions and services.....	23
2.4.3	P2P Device addressing.....	23
3	Functional description and procedures	25
3.1	P2P discovery.....	25
3.1.1	Introduction.....	25
3.1.2	Device Discovery procedures	25
3.1.3	Service Discovery procedures	38
3.1.4	Group Formation procedure.....	44
3.1.5	P2P Invitation procedure.....	54
3.2	P2P Group operation	58
3.2.1	P2P Group ID	59
3.2.2	Starting and maintaining a P2P Group session	59
3.2.3	Connecting to a P2P Group	61
3.2.4	P2P Group Owner services for P2P Client discovery	62
3.2.5	Persistent Group operation	64
3.2.6	Communication in a P2P Group	66
3.2.7	Disconnecting from a P2P Group	69
3.2.8	Disconnecting a P2P Client	69
3.2.9	Ending a P2P Group session.....	69



- 3.3 P2P Power Management 70
 - 3.3.1 Introduction 70
 - 3.3.2 Power Management and discovery 71
 - 3.3.3 Power Management at a P2P Group Owner 71
 - 3.3.4 Power Management at a P2P Client 79
- 3.4 Managed P2P Device operations 83
 - 3.4.1 Managed P2P Device capability 83
 - 3.4.2 P2P Coexistence Parameters operations 84
 - 3.4.3 WLAN Deauthentication/Disassociation 86
 - 3.4.4 Managed P2P Device Summary 87
- 4 Frame formats 89
 - 4.1 P2P Information Element 89
 - 4.1.1 P2P IE format 89
 - 4.1.2 Status attribute 92
 - 4.1.3 Minor Reason Code attribute 93
 - 4.1.4 P2P Capability attribute 94
 - 4.1.5 P2P Device ID attribute 97
 - 4.1.6 Group Owner Intent attribute 97
 - 4.1.7 Configuration Timeout attribute 98
 - 4.1.8 Listen Channel attribute 98
 - 4.1.9 P2P Group BSSID attribute 99
 - 4.1.10 Extended Listen Timing attribute 100
 - 4.1.11 Intended P2P Interface Address attribute 100
 - 4.1.12 P2P Manageability attribute 101
 - 4.1.13 Channel List attribute 102
 - 4.1.14 Notice of Absence attribute 103
 - 4.1.15 P2P Device Info attribute 105
 - 4.1.16 P2P Group Info attribute 106
 - 4.1.17 P2P Group ID attribute 107
 - 4.1.18 P2P Interface attribute 108
 - 4.1.19 Operating Channel attribute 108
 - 4.1.20 Invitation Flags attribute 109
 - 4.1.21 Out-of-Band Group Owner Negotiation Channel attribute 110

4.1.22	Service Hash attribute.....	111
4.1.23	Session Information Data Info.....	111
4.1.24	Connection Capability Info attribute	112
4.1.25	Advertisement ID Info attribute	112
4.1.26	Advertised Service Info attribute	113
4.1.27	Session ID Info attribute.....	114
4.1.28	Feature Capability Info attribute.....	115
4.1.29	Persistent Group Info attribute	115
4.2	Management Frames.....	116
4.2.1	Beacon frame format	116
4.2.2	Probe Request frame format.....	117
4.2.3	Probe Response frame format.....	118
4.2.4	Association/Reassociation Request frame format	119
4.2.5	Association/Reassociation Response frame format.....	120
4.2.6	Deauthentication frame format.....	120
4.2.7	Disassociation frame format	120
4.2.8	IP Address Allocation in EAPOL-Key Frames (4-Way Handshake).....	121
4.2.9	P2P public action frames	122
4.2.10	P2P action frames	131
4.2.11	Service Discovery action frames.....	133
4.2.12	FST action frames	136
4.3	DMG Frames	136
4.3.1	DMG Beacon and Announce frame format	136
4.3.2	Information request frame format.....	137
4.3.3	Information response frame format.....	138
4.4	Frame Usage	138
4.5	NFC NDEF Structure	141
4.5.1	NFC P2P Handover Request Message	141
4.5.2	NFC P2P Handover Select Message.....	144
Appendix A	P2P State Machine	147
Appendix B	P2P Specific WSC IE Attributes.....	156
B.1	Requested Device Type.....	156
B.2	Primary Device Type.....	157



Appendix C GAS Frame Field Value 158

 C.1 GAS Initial Request action frame 158

 C.2 GAS Initial Response Action Frame 160

 C.3 GAS Fragmentation 162

Appendix D P2P Discovery Diagrams 166

Appendix E Recommended Practices for Bonjour using P2P Service Discovery 183

 E.1 Example for Apple File Sharing over TCP 185

 E.2 Example for IP Printing over TCP 188

 E.3 DNS Name Compression..... 191

 E.4 Supported Service Type Hash (SSTH) 192

Appendix F Recommended Practices for UPnP using P2P Service Discovery 194

 F.1 Example 1—Search for UPnP internet gateway devices 196

 F.2 Example 2—Search for all UPnP root devices..... 197

 F.3 Example 3—Search for a specific device by its UUID 197

 F.4 Example 4—Search for all instances of a UPnP Media Server Content
 Directory Service 198

Appendix G Recommended Practices for Peer-to-Peer Services (P2Ps) using P2P
 Service Discovery..... 199

List of figures

Figure 1—P2P components and topology when operating outside DMG.....	20
Figure 2—P2P components and topology when operating within DMG.....	20
Figure 3—A subset of P2P 1:n topology (n=1).....	21
Figure 4—P2P Concurrent device.....	21
Figure 5—Example In-band Device Discovery procedures for a P2P Device operating outside DMG.....	31
Figure 6—Example In-band Device Discovery procedures for a P2P Device operating within DMG.....	32
Figure 7—Out-of-Band Device Discovery (NFC Negotiated Handover).....	36
Figure 8—Out-of-Band Device Discovery (NFC Static Handover).....	38
Figure 9—Example of Service Discovery procedure when operating outside DMG.....	43
Figure 10—Example of Service Discovery procedure when operating within DMG.....	44
Figure 11—Group Owner Negotiation message exchange.....	47
Figure 12—Group Owner determination flowchart.....	48
Figure 13—Example of Group Formation using NFC Out-of-Band Device Discovery...	54
Figure 14—Example of P2P Group Owner Opportunistic Power Save.....	73
Figure 15—P2P Group Owner Notice of Absence.....	75
Figure 16—P2P Group Owner Notice of Absence with Opportunistic Power Save.....	77
Figure 17—Illustration of P2P Group Owner power save state precedence rules.....	78
Figure 18—Example P2P WMM-PS operation with P2P Group Owner NoA.....	80
Figure 19—Shortening of P2P WMM-PS USPs by P2P Group Owner absence.....	81
Figure 20—P2P Presence Request-Response procedure.....	82
Figure 21—Managed P2P Device that is a P2P Concurrent Device.....	84
Figure 22—Example of P2P attributes carried in two P2P IEs.....	92
Figure 23—NFC P2P Handover Request Message.....	142
Figure 24—NFC P2P Handover Select Message.....	145
Figure A1—P2P State Machine.....	148
Figure C1—GAS Initial Request Action Frame Format.....	158
Figure C2—Advertisement Protocol Information Element.....	158
Figure C3—ANQP Query Request Field.....	159
Figure C4—ANQP Query Request Frame Vendor-specific Content.....	159



Figure C5—GAS Initial Response Action Frame Format 160

Figure C6—Advertisement Protocol Information Element 161

Figure C7—ANQP Query Response Field Format 161

Figure C8—ANQP Query Response Frame Vendor-specific Content Field 162

Figure C9—GAS Comeback Request Frame Format 163

Figure C10—GAS Comeback Response Frame Format 163

Figure C11—Advertisement Protocol IE 164

Figure C12—Example GAS Fragmentation Frame Exchange Sequence 165

Figure E1—Query Request Vendor-specific Content 183

Figure E2—Bonjour Query Data 183

Figure E3—Query Response Vendor-specific Content 184

Figure E4—Response Data 184

Figure E5—AFP Over TCP Query Data (human readable) 185

Figure E6—AFP Over TCP Query Data (encoded and compressed) 186

Figure E7—AFP over TCP Response Data (human readable) 186

Figure E8—AFP over TCP Response Data (encoded and compressed) 186

Figure E9—AFP Over TCP Query Data for Example (human readable) 187

Figure E10—AFP Over TCP Query Data for Example (encoded and compressed) ... 187

Figure E11—AFP over TCP Response Data for Example (human readable) 187

Figure E12—AFP over TCP Response Data for Example (encoded and compressed)
..... 188

Figure E13—IPP Over TCP Query Data (human readable) 188

Figure E14—IPP Over TCP Query Data (encoded and compressed) 188

Figure E15—IPP over TCP Response Data (human readable) 189

Figure E16—IPP over TCP Response Data (encoded and compressed) 189

Figure E17—IPP Over TCP Query Data for MyPrinter (human readable) 190

Figure E18—IPP Over TCP Query Data for MyPrinter (encoded and compressed) ... 190

Figure E19—IPP over TCP Response Data for MyPrinter (human readable) 190

Figure E20—IPP over TCP Response Data for MyPrinter (encoded and compressed)
..... 191

Figure F1—Vendor-specific Content in ANQP Query Request 195

Figure F2—Vendor-specific content in ANQP Query Response 195

Figure F3—Query Data 195



Figure F4—Response Data..... 195

Figure F5—Query Request for UPnP Internet Gateway Devices..... 197

Figure F6—Query Response for UPnP Internet Gateway Devices 197

Figure F7—Query Request for all UPnP root devices 197

Figure F8—Query Response for all UPnP root devices 197

Figure F9—Query Request for a UPnP device by its UUID 198

Figure F10—Query Response for a UPnP device by its UUID..... 198

Figure F11—Query Request for all instances of a UPnP Media Server CDS 198

Figure F12—Query Response for all instances of a UPnP Media Server CDS..... 198

List of tables

Table 1—Summary of WSC Config Methods and Device Password ID usage	46
Table 2—P2P Coexistence Parameters setting	85
Table 3—Summary of requirements on Managed P2P Devices	87
Table 4—P2P IE format	89
Table 5—General format of P2P attribute	90
Table 6—P2P Attribute ID definitions	90
Table 7—Status attribute format	92
Table 8—Status Code definitions	92
Table 9—Minor Reason Code attribute format	93
Table 10—Minor Reason Code definitions	94
Table 11—P2P Capability attribute format	94
Table 12—Device Capability Bitmap definition	95
Table 13—Group Capability Bitmap definition	95
Table 14—P2P Device ID attribute format	97
Table 15—Group Owner Intent attribute format	97
Table 16—GO Intent field definition	98
Table 17—Configuration Timeout attribute format	98
Table 18—Listen Channel attribute format	99
Table 19—P2P Group BSSID attribute format	99
Table 20—Extended Listen Timing attribute format	100
Table 21—Intended P2P Interface Address attribute format	100
Table 22—P2P Manageability attribute format	101
Table 23—Manageability Bitmap field format	101
Table 24—Channel List attribute format	102
Table 25—Channel Entry field format	102
Table 26—Notice of Absence attribute format	103
Table 27—CTWindow and OppPS Parameters field format	104
Table 28—Notice of Absence Descriptor format	104
Table 29—Device Info attribute format	105
Table 30—P2P Group Info attribute format	106

Table 31—P2P Client Info Descriptor format	106
Table 32—P2P Group ID attribute format	107
Table 33—P2P Interface attribute format	108
Table 34—Operating Channel attribute format.....	108
Table 35—Invitation Flags attribute format.....	109
Table 36—Invitation Flags Bitmap definition	109
Table 37— Out-of-Band Group Owner Negotiation Channel attribute format	110
Table 38— Role indication field.....	110
Table 39 – Service Hash attribute format	111
Table 40 - Session Information Data Info attribute format.....	112
Table 41 - Connection Capability Info attribute format	112
Table 42 - Advertisement ID Info attribute format.....	113
Table 43 - Advertised Service Info Attribute format.....	113
Table 44 - Advertised Service Descriptor format.....	114
Table 45 - Session ID Info Attribute definitions	114
Table 46 - Feature Capability Info attribute format	115
Table 47 - Persistent Group Info Attribute format.....	116
Table 48—P2P attributes in the Beacon frame	116
Table 49—Probe Request frame format.....	117
Table 50—Additional attributes in WSC IE in the Probe Request frame	117
Table 51—P2P attributes in the Probe Request frame.....	117
Table 52—P2P attributes in the Probe Response frame.....	118
Table 53—P2P attributes in the Association/Reassociation Request frame	119
Table 54—P2P attributes in the Association/Reassociation Request frame sent to a WLAN AP by a Managed P2P Device.....	119
Table 55—P2P attributes in the Association/Reassociation Response frame.....	120
Table 56—P2P attributes in the Deauthentication frame.....	120
Table 57—P2P attributes in the Disassociation frame	120
Table 58—IP Address Request KDE in the EAPOL-Key frame 2	121
Table 59—IP Allocation KDE in the EAPOL-Key frame 3	121
Table 60—General format of P2P public action frame	122
Table 61—P2P public action frame type	122
Table 62—P2P attributes in the GO Negotiation Request frame	123



Table 63—WSC IE in the GO Negotiation Request frame	123
Table 64—P2P attributes in the GO Negotiation Response frame.....	124
Table 65—WSC IE in the GO Negotiation Response frame	125
Table 66—P2P attributes in the GO Negotiation Confirmation frame	125
Table 67—P2P attributes in the P2P Invitation Request frame	126
Table 68—WSC IE in the P2P Invitation Request Frame.....	126
Table 69—P2P attributes in the P2P Invitation Response frame	127
Table 70—P2P attributes in the Device Discoverability Request frame	128
Table 71—P2P attributes in the Device Discoverability Response frame	128
Table 72—P2P attributes in the Provision Discovery Request frame.....	128
Table 73 - P2P attributes in the Provision Discovery Response frame	130
Table 74—General format of P2P action frame	131
Table 75—P2P action frame type	131
Table 76—Service Discovery Vendor-specific Content.....	133
Table 77—Service Request TLV Fields	133
Table 78—Service Protocol Types.....	134
Table 79—Service Response TLV Fields.....	135
Table 80—Service Discovery Status Codes.....	135
Table 81—P2P attributes in FST Setup Request and FST Setup Response frames ..	136
Table 82—P2P attributes in the DMG Beacon and Announce frames	136
Table 83—Information Request frame format	137
Table 84—Additional WSC IE attributes for the Information Request frame	137
Table 85—P2P IE attributes for the Information Request frame	137
Table 86—P2P IE attributes for the Information Response frame.....	138
Table 87—Frame subtype usage	139
Table 88—Mandatory WSC attributes in the P2P Carrier Configuration Record.....	143
Table 89—P2P attributes in the P2P Carrier Configuration Record	143
Table F1— Query Values.....	196
Table G1 - Query Data format in ANQP Query Request Frame Vendor-Specific Content for P2Ps	199
Table G2 - Response Data format in ANQP Query Response Vendor-specific Content for P2Ps	200
Table G3 - Service Info Descriptor format	200



1 Introduction

This document is the technical specification for Wi-Fi CERTIFIED Wi-Fi Direct®, a solution for Wi-Fi® device-to-device connectivity. This specification defines an architecture and set of protocols that facilitate Wi-Fi Direct operation and that are backward compatible with existing Wi-Fi CERTIFIED™ devices when these devices operate outside Directional Multi-Gigabit (DMG). For devices operating within DMG, there are no requirements on backward compatibility with existing Wi-Fi CERTIFIED devices. The term “P2P” found throughout this document is interchangeable with “Wi-Fi Direct”

1.1 Scope

The scope of the feature requirements is limited to that defined in this specification. The content of this specification is designed to address the solution requirement areas including:

- Discovery (Device Discovery and Service Discovery),
- Pairing (including Group Formation and peer-to-peer (P2P) Invitation),
- Connectivity,
- Power Management when operating outside DMG,
- Group Management,
- Coexistence when operating outside DMG, and
- Legacy for operation outside DMG.

1.2 References

- [1] IEEE 802.11-2020 IEEE Standard for Information technology – Telecommunications and information exchange between systems – Local and metropolitan area networks – Specific requirements – Part 11: Wireless LAN Medium Access Control (MAC) and Physical Layer (PHY) specifications
- [2] Wi-Fi Protected Setup Specification, Wi-Fi Alliance®, <https://www.wi-fi.org/discover-wi-fi/specifications>
- [3] WMM® Specification – version 1.1, Wi-Fi Alliance, <https://www.wi-fi.org/discover-wi-fi/specifications>
- [4] Bonjour, <http://developer.apple.com/networking/bonjour/index.html>
- [5] Universal Plug and Play (UPnP), <http://www.upnp.org>
- [6] Web Services Dynamic Discovery (WS-Discovery), April 2005, <http://specs.xmlsoap.org/ws/2005/04/discovery/ws-discovery.pdf>
- [7] Connection Handover Technical Specification 1.2, 2010-07-07, NFC Forum, NFCForum-TS-ConnectionHandover_1_2.doc



- [8] NFC Data Exchange Format (NDEF) 1.0, 2006-07-24, NFC Forum, NFCForum-TS-NDEF_1.00
- [9] NFC Forum Logical Link Control Protocol Specification, NFC Forum, 2009
- [10] Wi-Fi Peer-to-Peer Services Technical Specification, Wi-Fi Alliance, <https://www.wi-fi.org/discover-wi-fi/specifications>
- [11] IEEE Std 802.11ax-2021 IEEE Standard for Information technology – Telecommunications and information exchange between systems – Local and metropolitan area networks – Specific requirements – Part 11: Wireless LAN Medium Access Control (MAC) and Physical Layer (PHY) specifications. Amendment 1: Enhancements for High Efficiency WLAN

1.3 Definitions

The following definitions and terms are used in this document:

Alternative Carrier: The Wi-Fi communication technology that can be used for data transfers between an NFC Handover Requester and an NFC Handover Selector.

Config Methods: The Wi-Fi Protected Setup configuration methods supported, as defined in the Wi-Fi Protected Setup Specification [2].

Client: A P2P Client or a Legacy Client that is connected to a P2P Group Owner.

Credentials: The information that is required to join a P2P Group as defined in the Wi-Fi Protected Setup Specification [2].

Device Password ID: The Wi-Fi Protected Setup configuration method currently in use, as defined in the Wi-Fi Protected Setup Specification [2].

Directional Multi-Gigabit (DMG): A frequency band wherein the operating channel center frequency is above 45 GHz.

Discovery DMG Beacon: A DMG Beacon with the Discovery Mode field equal to 1.

Find Phase: A phase in P2P Discovery that is used to ensure that two simultaneously searching P2P Devices arrive on a common channel to enable communication.

In-band: Data transfer using the WLAN communication channel, including WLAN multiband devices (e.g. 2.4 GHz, 5 GHz, 6 GHz, and 60 GHz).

Legacy Client: A STA that is Wi-Fi CERTIFIED, but not P2P compliant.

Listen Channel: The channel chosen from the set of Social Channels, which is used by a P2P Device to be discoverable.

Listen State: A state used in P2P Discovery in which a P2P Device dwells on a Listen channel to be discoverable.



Managed P2P Device: A P2P Device that has the capability to be managed by a WLAN infrastructure.

NFC Device: NFC Forum compliant contactless device that support the following Modus Operandi: Initiator, Target, and Reader/Writer. It may also support card emulator.

NFC Handover Requester: An NFC Forum Device that begins the Handover Protocol by issuing a Handover Request Message to another NFC Forum Device.

NFC Handover Selector: Either 1. or 2.

1. an NFC Forum Device that constructs and replies to a Handover Select Message as a result of a previously received Handover Request Message
2. an NFC Forum Tag that provides a pre-set Handover Select Message for reading.

NFC Interface: NFC Interface: Contactless interface of an NFC Device.

NFC-LLCP: The Logical Link Control Protocol (LLCP) specification between two NFC Forum Devices [9].

NFC Tag: NFC Forum compliant contactless memory card that can be read or written by an NFC Device and may be powered by the RF field.

Operating Channel: The channel on which the P2P Group is operating.

Out-of-Band: Data transfer using a communication channel other than the WLAN

P2P Client: A P2P Device that is connected to a P2P Group Owner.

P2P Coexistence Parameters: A combination of Primary P2P Coexistence Parameters and Secondary P2P Coexistence Parameters.

P2P Concurrent Device: A P2P Device that can concurrently operate as a WLAN STA in WLAN.

P2P Device: Wi-Fi Direct device that is capable of acting as both a P2P Group Owner and a P2P Client.

P2P Device Address: An identifier used to uniquely reference a P2P Device.

P2P Discovery: A capability that provides a set of functions to allow a device to easily and quickly identify and connect to a device and its services in its vicinity.

P2P Group: A set of devices consisting of one P2P Group Owner and zero or more Clients.

P2P Group Address: An identifier used to uniquely reference the P2P Device Address field of the P2P Group ID attribute.

P2P Group ID: An identifier used to indicate the presence of a specific P2P Group.

P2P Group Owner: An “AP-like” entity, when not operating within DMG, or PCP, when operating within DMG, that may provide and use connectivity between Clients.

P2P Interface Address: The MAC address of the P2P interface, an address used to identify a P2P Device within a P2P Group.

PBSS Control Point (PCP): the STA that coordinates access to the wireless medium and transmits DMG Beacon frames in a PBSS.

Persistent P2P Group: A P2P Group for which Credentials are stored and may be made available for reuse after the initial use completes. Such a P2P Group has a lifetime that may extend over a number of distinct sessions beyond the initial use until the group is deliberately dissolved.

Personal Basic Service Set (PBSS) Personal Basic Service Set (PBSS): a basic service set (BSS) which forms a self-contained network, operates within DMG, and includes one PBSS control point (PCP). Access to a distribution system (DS) is not present in a PBSS, but an intra-PBSS forwarding service is optionally present.

P2P Wildcard SSID: The SSID field “DIRECT-”.

Primary P2P Coexistence Parameters: One or more Channel Usage elements (see IEEE 802.11-2020 [1]).

Provisioning: A phase of P2P Group Formation in which Credentials for the P2P Group are exchanged based on the use of Wi-Fi Protected Setup [2].

Search State: A state in the Find Phase in which a P2P Device sends Probe Request frames on the Social Channels.

Secondary P2P Coexistence Parameters: Zero or one Country and Power Constraint element pairs where the Country element includes a Maximum Transmit Power Level field, and zero or one WMM Parameter Elements.

Security Domain: An environment comprised of a set of devices that use common security credentials and policies.

Scan Phase: The process in P2P Discovery to collect information about surrounding devices or networks by scanning all supported channels.

Social Channel: A subset of commonly available channels in the 2.4 GHz band (channels 1, 6, and 11) and in the 60 GHz band within DMG (channel 2).

Temporary P2P Group: A P2P Group that is formed only when required and ceases to exist after the initial use completes. Such a P2P Group has a lifetime consisting of a single use.

Topology: The arrangement in which the nodes of a network are connected to each other and (in some cases) to other networks.

1.4 Abbreviations and acronyms

A-BFT	Association Beamforming Training
AP	Access Point
AM	Active Mode
ANQP	Access Network Query Protocol
ATI	Announcement Transmission Interval
BTI	Beacon Transmission Interval
CTWindow	Client Traffic Window
DMG	Directional Multi-Gigabit
EOSP	End-of-Service-Period
FST	Fast Session Transfer
GAS	Generic Advertisement Service
GCMP	Galois/Counter Mode Protocol
GO	P2P Group Owner
L2	OSI Layer 2, a Data Link Layer protocol
L3	OSI Layer 3, a Network Layer protocol
NDEF	NFC Data Exchange Format
NFC	Near Field Communication
NoA	Notice of Absence
OFDM	Orthogonal Frequency Division Multiplexing
OppPS	Opportunistic Power Save
P2P	Peer-to-Peer
P2Ps	Peer-to-Peer services
PS	Power Save mode
P2P IE	P2P Information Element
P2P PS	IEEE802.11 Power Save adapted for P2P operation
P2P WMM-PS	WMM-PS adapted for P2P operation
PBSS	Personal Basic Service Set
PCP	PBSS Control Point
QoS	Quality of Service
RA	Receiver Address
SA	Source Address



SD	Service Discovery
SSW	Sector Sweep
STA	Non-AP Station
TA	Transmitter Address
TIM	Traffic Information Map
TBTT	Target Beacon Transmission Time
TLV	Type-Length-Value
TS	Traffic Stream
TU	Time Unit
UPnP	Universal Plug and Play™
USP	Unscheduled Service Period
WLAN	Wireless Local Area Network
WMM®	Wi-Fi Multimedia™
WPA2™	Wi-Fi Protected Access® 2
WMM-PS	Wi-Fi Multimedia Power Save
WSC	Wi-Fi Simple Configuration, used for Wi-Fi Protected Setup™

2 Architectural overview

2.1 P2P components

The P2P architecture consists of components that interact to support device-to-device communication.

P2P Device:

- Supports both P2P Group Owner and P2P Client roles.
- Negotiates P2P Group Owner or P2P Client role.
- Supports WSC and P2P Discovery mechanism.
- May support WLAN and P2P concurrent operation.

P2P Group Owner role:

- “AP-like” entity that provides BSS functionality and services for associated Clients (P2P Clients or Legacy Clients) when not operating within DMG, or a PCP that provides PBSS functionality and services for Clients (P2P Clients) when operating within DMG.
- Provides WSC Internal Registrar functionality.
- May provide communication between associated Clients.
- May provide access to a simultaneous WLAN connection for its associated Clients.

P2P Client role:

- Implements non-AP STA functionality.
- Provides WSC Enrollee functionality.

2.2 P2P topology

The P2P Topology is 1:n where multiple Clients are connected to one Group Owner. Such a set of connected devices is called a P2P Group. Each Client in a P2P Group operating outside DMG may be either a P2P Client or a Legacy Client, as shown in Figure 1. A P2P Group operating within DMG only includes P2P Clients, as shown in Figure 2.

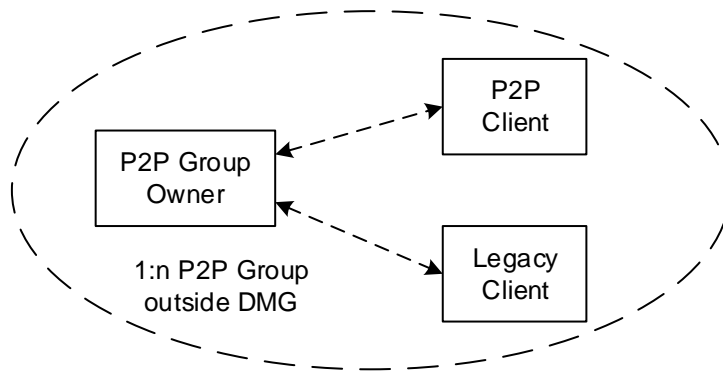

Figure 1—P2P components and topology when operating outside DMG

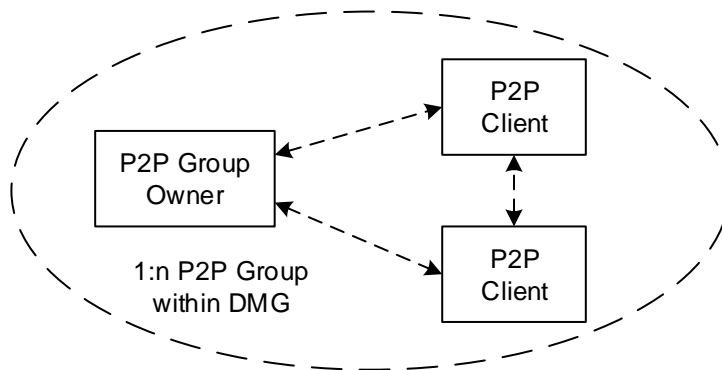

Figure 2—P2P components and topology when operating within DMG

A P2P Group has a single SSID and provides one security domain.

Figure 3 illustrates a 1:1 topology, which is a subset of P2P 1:n topology (n=1).

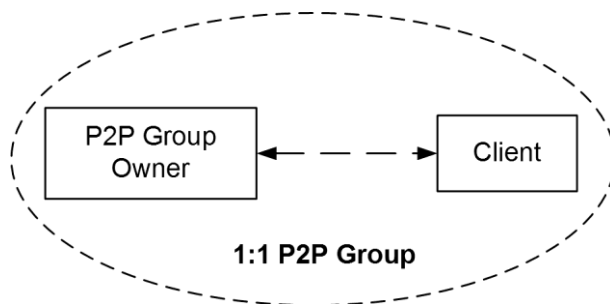

Figure 3—A subset of P2P 1:n topology (n=1)

2.3 Concurrent operation

A P2P Device can operate concurrently with a WLAN (infrastructure network). Such a device is considered a P2P Concurrent Device. The concurrent operation requires a device to support multiple MAC entities.

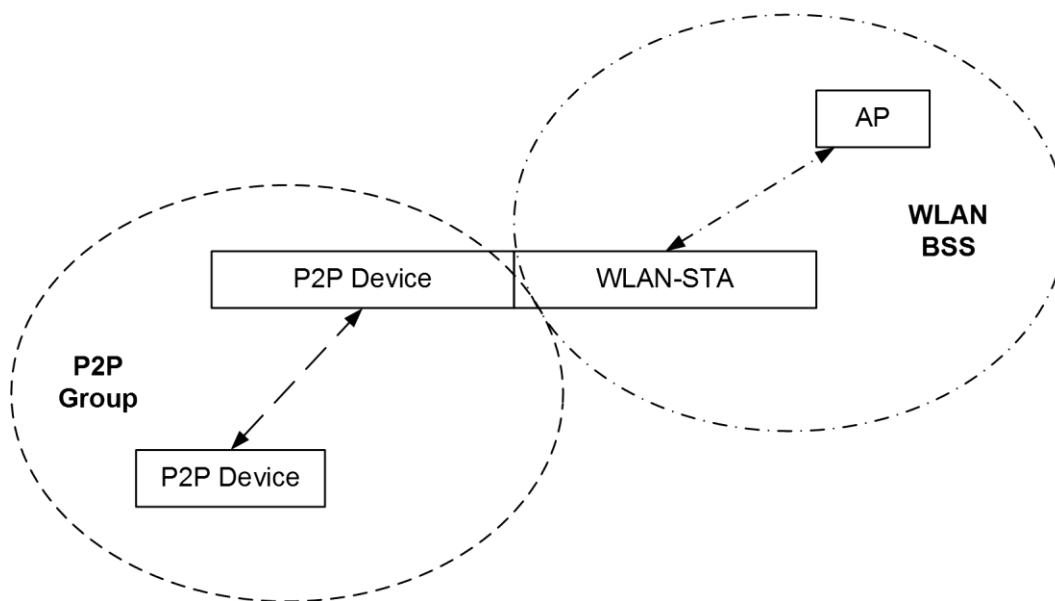

Figure 4—P2P Concurrent device

As an example, Figure 4 shows a P2P Concurrent Device that has one MAC entity operating as a WLAN-STA and the second MAC entity operating as a P2P Device. The dual MAC functionality can be provided via two separate physical MAC entities each associated with its own PHY entity, two virtual MAC entities over one PHY entity, or any other approach. Implementation of multiple MAC functionality is out of scope of this specification.

A P2P Group may operate in the same or different operating class and channel as a concurrently operating WLAN BSS. For example, a WLAN BSS may

operate in channel 36 in the 5.2 GHz band, while the P2P Group may operate in channel 6 in the 2.4 GHz band or in channel 2 in the 60 GHz band within DMG.

This specification does not preclude a P2P Device operating as a member of more than one P2P Group simultaneously, however, such operation is out of scope and therefore not described.

2.4 Functions and services

2.4.1 Basic functions and services

For P2P operation outside the DMG, this specification assumes that the following STA functions and services are implemented in P2P Devices:

- IEEE 802.11g or newer 2.4 GHz PHY [1]
- IEEE 802.11i (AES-CCMP) [1]
- Wi-Fi Protected Setup [2]
- Wi-Fi Multimedia [3]

For P2P operation within DMG, this specification assumes that the following STA functions and services are implemented in P2P Devices:

- DMG operation as defined in IEEE 802.11-2020 [1]
- AES-GCMP as defined in IEEE 802.11-2020 [1]
- Wi-Fi Protected Setup [2]

Any required ‘AP-like’ functions and services required for P2P Group Owner operation outside DMG are described within this specification. A P2P Group Owner operating within DMG is required to support PCP functions and services.

In order to promote efficient wireless medium use when operating outside DMG:

- P2P Devices shall not use 11b rates (1, 2, 5.5, 11 Mbps) for data and management frames except:
 - Probe Request frames sent to both P2P Devices and non-P2P Devices.
- P2P Devices shall not respond to Probe Request frames that indicate support for 11b rates only.

Note 1 — This means that the P2P Group Owner transmits Beacon frames using OFDM.

Note 2 — This means that the P2P Group Owner transmits Probe Response frames using OFDM, including frames sent in response to Probe Requests received at 11b rates from non 11b-only devices.

Note 3 — P2P Devices shall not include 11b rates in the list of supported rates in Probe Request frame intended only for P2P Devices. 11b rates may be included in the list of supported rates in Probe Request frames intended for both P2P Devices and non-P2P Devices.

2.4.2 P2P specific functions and services

In addition to the assumed functions listed in Section 2.4.1, a P2P Device supports the following P2P specific functions:

- **P2P Discovery** provides a set of functions to allow a device to easily and quickly identify and connect to another P2P Device and its services in its vicinity.
- **P2P Group Operation** resembles infrastructure BSS operation when operating outside DMG and PBSS operation when operating with DMG, as defined in IEEE 802.11-2020 [1], and provides additions for a P2P Group operation.
- **P2P Power Management** provides a set of functions to reduce power consumption of P2P Devices that operate outside DMG.
- **Managed P2P Device Operation** (optional) describes the ability for P2P Devices to operate in an enterprise environment where P2P Devices may be managed by the Information Technology (IT) department of the enterprise.

Note — An informative diagram shown in Appendix A illustrates P2P Device state transitions.

2.4.3 P2P Device addressing

A P2P Device shall have a P2P Device Address, conforming to the format as described in Section 9.2.4.3.2 of IEEE 802.11-2020 [1], which is used to uniquely reference that P2P Device. The P2P Device Address of a P2P Device shall be its globally administered MAC address, or its globally administered MAC address with the locally administered bit set. The P2P Device Address shall be used as the receiver address (RA) for all frames sent to a P2P Device during P2P Discovery, with the sole exception of using a broadcast receiver address in a Probe Request. The P2P Device Address shall be used as the transmitter address (TA) for all frames sent by a P2P Device during P2P Discovery.

A P2P Device will assume the role of P2P Group Owner or P2P Client when in a P2P Group. The P2P Device is a different logical entity from the P2P Client or P2P Group Owner so has its own addressing mechanism. The P2P Device shall assign a P2P Interface Address, corresponding to the format as described in Section 9.2.4.3.2 of IEEE 802.11-2020 [1], which is used to communicate with the P2P Group Owner or Clients within a P2P Group. A P2P Interface Address is not required to be globally unique and may be locally administered. A P2P Interface Address may be the same as the P2P Device Address provided the requirements for P2P Interface Address in this clause are satisfied. A P2P Device shall use its P2P Interface Address as the transmitter address (TA) for all frames sent within a P2P Group. A P2P Device shall use the P2P Interface Address of the intended recipient P2P Device as the receiver address (RA) for all unicast frames sent within a P2P Group.



A P2P Device shall only use a P2P Interface Address for communication within a P2P Group. All other communication between P2P Devices shall use the P2P Device Address.

A P2P Group has a session that starts and ends as described in Section 3.2 and subsections. A Persistent P2P Group may have multiple distinct sessions. The P2P Interface Address shall be assigned prior to starting a P2P Group session and shall not change within a P2P Group session. The P2P Interface Address expires at the end of a P2P Group session. A P2P Device may use a different P2P Interface Address for distinct sessions of a P2P Group. A P2P Device shall not attempt to communicate to a P2P Device using a P2P Interface Address from a P2P Group session that has ended.

As described in Section 2.3 a P2P Device may support more than one interface for the purpose of a concurrent WLAN connection. A P2P Device shall assign a P2P Interface Address for the P2P Group that is distinct from the address used for the concurrent WLAN connection.

As discussed in Section 2.3 a P2P Device may support more than one interface for the purpose of membership of multiple P2P Groups. A P2P Device shall assign a different P2P Interface Address for each P2P Group for which it is concurrently a member.

The BSSID (Address 3 field value) to be used in frames sent by a P2P Device during the Find Phase and during Group Operation is specified in Section 3.1.2.1.3 and Section 3.2.2. When communication is not within a P2P Group, e.g. during Service Discovery, P2P Invitation, GO Negotiation and Device Discoverability, a P2P Device shall use the P2P Device Address of the intended destination as the BSSID in Request, or Confirmation frames and its own P2P Device Address as the BSSID in Response frames.

3 Functional description and procedures

3.1 P2P discovery

3.1.1 Introduction

P2P Discovery enables P2P Devices to quickly find each other and form a connection.

P2P Discovery consists of the following major components:

- **Device Discovery** facilitates two P2P Devices arriving on a common channel and exchanging device information (e.g. device name and device type).
- **Service Discovery** is an optional feature that allows a P2P Device to discover available higher-layer services prior to forming a connection.
- **Group Formation** is used to determine which device will be the P2P Group Owner and form a new P2P Group.
- **P2P Invitation** is used to invoke a Persistent P2P Group or invite a P2P Device to join an existing P2P Group.

Note – During P2P Discovery, a DMG STA can ignore P2P public action frames received outside of a beacon interval if it does not know how to respond to such frames.

3.1.2 Device Discovery procedures

3.1.2.1 Basic mechanisms of Device Discovery

The objective of P2P Device Discovery is to find P2P Devices and quickly determine the P2P Device to which a connection will be attempted. In-band P2P Device Discovery consists of two major phases: Scan and Find, which are described in detail in the following sections. Alternatively, if two P2P Devices support NFC, the user may specify the target device by touching the P2P Device's NFC Interface to the corresponding device's NFC Interface. Such NFC Out-of-Band Device Discovery is defined in Section 3.1.2.7.

In-band Device Discovery uses Probe Request and Probe Response frames to exchange device information. When operating outside DMG, the P2P Devices in a P2P Group are discovered via a Probe Response frame from the P2P Group Owner. When operating within DMG, P2P Devices in a P2P Group are normally discovered via an SSW frame received in response to a DMG Beacon transmission as described in Section 11.1.4.3 of IEEE 802.11-2020 [1]; Probe Request and Probe Response frames are subsequently used to exchange device information. Alternatively, Probe Request and Probe Response frames may be used instead of SSW frames for devices that do not use beamforming.

A P2P Device shall not respond to Probe Request frames unless it is:

- a P2P Group Owner or
- in the Listen State, or
- in the Search State and the P2P Device operates within DMG, or
- a P2P Device associated with an infrastructure AP on the channel on which the Probe Request was sent — in which case the P2P Device may respond provided it is not already a member of a P2P Group, or
- a P2P Client supporting Peer-to-Peer services (P2Ps) [10], having a Service Advertiser with a Service Hash matching the hash value in the incoming Probe Request, as described in 3.4.3.2 (Advertise Service fields in Probe Response) of [10], on the operating channel of the P2P group that the client connected.

When operating outside DMG, a P2P Device shall not transmit Beacon frames unless it is a P2P Group Owner.

Note 1 — Section 2.4.1 contains additional rules that apply to frames sent during In-band Device Discovery.

Note 2 – When operating within DMG, the requirements for DMG Beacon transmission are described in IEEE 802.11-2020 [1].

3.1.2.1.1 Listen State

A P2P Device that is not in a P2P Group may use the Listen State to become discoverable. In the Listen State a P2P Device dwells on a given channel, termed the Listen Channel. This is a channel chosen from the list of Social Channels. Channels 1, 6, and 11 in the 2.4 GHz band and channel 2 in the 60 GHz band within DMG shall be used as the Social Channels. The Listen Channel shall be chosen at the beginning of the In-band Device Discovery and shall remain the same until P2P Discovery completes.

As specified in Section 11.1.4.3.3 of IEEE 802.11-2020 [1], when operating within DMG a P2P Device may perform beamforming with another P2P Device before Probe Request and Probe Response frames can be exchanged between the devices. Therefore, as specified in Section 11.1.4.3.3 of IEEE 802.11-2020 [1], a P2P Device in Listen State that receives a Discovery DMG Beacon frame performs the procedure specified in Section 10.42.5 of IEEE 802.11-2020 [1] before exchanging Probe Request and Probe Response frames.

When operating within DMG, a P2P Device in Listen State that responds to a Probe Request or Discovery DMG Beacon frame transmitted by a peer P2P Device may need to initiate beamforming with the peer P2P Device to restore or refine the communication link.

A P2P Device operating within DMG and in Listen State

- Shall not transmit any frame before receiving a Probe Request or Discovery DMG Beacon frame from a peer P2P Device.
- Shall only transmit control or management frames sent in response to a management frame from the peer P2P Device.

- Shall only transmit control frames to initiate or complete beamforming with the peer P2P Device with the RA field set to the P2P Device Address of the peer P2P Device, for example, Grant, Grant Ack, SSW, SSW-Feedback and SSW-ACK frames. Note that a Peer P2P Device in this case may not be able to respond to a beamforming request until it moves to Listen State or repeats the Scan Phase.

A P2P Device in the Listen State shall only reply to Probe Request frames that contain the P2P IE, the P2P Wildcard SSID element, a Wildcard BSSID, and a Destination Address that is either the broadcast address or its P2P Device Address. If one or more Requested Device Type attributes are present in the WSC IE in the Probe Request frame, the P2P Device in the Listen State shall only respond with a Probe Response frame if it has a Primary Device Type or Secondary Device Type value identical to any of the Requested Device Type values. If a Device ID attribute is present in the P2P IE in the Probe Request frame, the P2P Device in the Listen State shall only respond with a Probe Response frame if its Device Address matches that in the Device Address field in the Device ID attribute.

One or more P2P IEs and the WSC IE shall be inserted after other information elements in the Probe Response frames transmitted by a P2P Device. The inclusion of the WSC IE in the Probe Response frame sent by a P2P Device allows it to advertise human-readable device-specific information. The WSC IE shall contain the required attributes for an AP/Registrar as described in Section 8.2.5 (Probe Response (D-AP/Registrar)) of [2]. Device Password ID shall be a required attribute if Credentials are available and ready for immediate use.

Note — Examples of Credentials being ‘available and ready for immediate use’ include active pushbutton mode (pushbutton method), PIN being displayed (Display method) and PIN entered (Keypad method).

A P2P Device in the Listen State shall set the Source Address (SA) and BSSID to its P2P Device Address, and shall set the SSID to the P2P Wildcard SSID in all Probe Response frames that it sends. If the Probe Response is transmitted outside DMG, the P2P Device shall set the ESS bit of the Capabilities field in the Probe Response frame to 0 and IBSS bit to 0. If the Probe Response is transmitted within DMG, the P2P Device shall set the BSS Type subfield of the Capabilities field in the Probe Response frame to 1 (non-PCP/non-AP DMG STA).

The Find Phase, as described in Section 3.1.2.1.3 makes use of the Listen State. The P2P Device in the Find Phase shall stay in the Listen State for the time periods defined in the Find Phase and shall be constantly available within those time periods.

When not in Find Phase, a P2P Device may stay in the Listen State for an extended period of time. Any interruption in availability, for example to scan or use power save mechanisms as defined in IEEE 802.11-2020 [1], may result in lengthened or unreliable discovery. A P2P Device should be available in the Listen State for at least a contiguous period of 500ms every 5s in order to

enable other P2P Devices to discover it. A P2P Device may support reconnection of a Persistent P2P Group in which case it may need to modify this timing, as described in Section 3.2.5.

3.1.2.1.2 Scan Phase

The Scan Phase uses the scanning process defined in IEEE 802.11-2020 [1]. It may be used by a P2P Device to find P2P Devices or P2P Groups and to locate the best potential Operating Channel to establish a P2P Group. In the Scan Phase, devices collect information about surrounding devices or networks by scanning all supported channels.

The P2P Device in the Scan Phase shall not reply to Probe Request frames.

A P2P Device may simultaneously scan for P2P Groups and legacy networks (i.e. 802.11 infrastructure networks). The WSC IE shall be included in all Probe Request frames, with Device Name, Primary Device Type and Device Password ID as required attributes. A P2P Device that uses PushButton configuration method shall indicate when it is in active pushbutton mode (i.e. during the 120 second walk time after the user has pressed the push button) by setting the Device Password ID value to PushButton. Secondary Device Type List shall be an optional attribute. A P2P Device may send a Probe Request frame containing the P2P IE and the Wildcard SSID to elicit Probe Response frames from both legacy networks and P2P Group Owners. Inclusion of the P2P IE in the Probe Request frame is required to enable the P2P Group Owner to include the P2P Group Info attribute in the Probe Response frame. P2P Clients shall not reply to Probe Request frames so they can only be discovered by the Probe Response frame from the P2P Group Owner containing the P2P Group Info attribute, as described in Section 3.2.4.

A P2P Device may limit its Scan to P2P Devices and Groups. A Probe Request frame intended only for P2P Devices shall include the P2P IE and shall have the SSID element set to the P2P Wildcard SSID.

Note — There is a very low probability of a legacy network that has the P2P Wildcard SSID as its SSID; such a Probe Response frame may be identified by the lack of the P2P IE.

A P2P Device may narrow its scan to either:

- a specific device type, or device types by including the WSC IE with one or more Requested Device Type attribute in the Probe Request frame. The Requested Device Type attribute has the same format as the Primary Device Type attribute in the Wi-Fi Protected Setup specification [2].
- a specific P2P Device by including the P2P Device ID attribute in the P2P IE in the Probe Request frame. This provides a mechanism to scan for a specific P2P Device.

3.1.2.1.3 Find Phase

The Find Phase is used to ensure that two P2P Devices performing Device Discovery arrive on a common channel to enable communication. This is achieved by cycling between states where the P2P Device waits on a fixed channel for Probe Request or Discovery DMG Beacon frames (the Listen State) or sends Probe Request or Discovery DMG Beacon frames on a fixed list of channels (the Search State). Convergence of two devices on the same channel is assisted by randomizing the time spent in each cycle of the Listen State. Time to converge is minimized by limiting the list of channels to a small set known as the Social Channels. In the Find Phase, a P2P Device shall alternate between the Listen and Search states as specified below.

The duration of each Listen State within the Find Phase shall be a random integer of 100 TU Intervals. This random integer shall be no greater than the `maxDiscoverableInterval` value and no less than the `minDiscoverableInterval` value. Default values for `maxDiscoverableInterval` and `minDiscoverableInterval` values are 3 and 1 respectively. The randomness in the time spent in the Listen state is to avoid a case where two P2P Devices in the Find Phase are in lock-step and thus will never find each other. While in the Listen State within the Find Phase a P2P Device shall be constantly available on the Listen Channel.

The values for `maxDiscoverableInterval` and `minDiscoverableInterval` shall be nonzero.

The duration of each Search State within the Find phase is implementation dependent.

P2P Devices in the Search State shall transmit one or more Probe Request or Discovery DMG Beacon frames on each of the Social Channels supported by the P2P Device. All Probe Request frames transmitted by P2P Devices in the Search State shall:

- Include the P2P IE.
- Include the WSC IE, with Device Name, Primary Device Type, and Device Password ID as required attributes. Secondary Device Type List shall be an optional attribute. A P2P Device that uses PushButton configuration method shall indicate when it is in active pushbutton mode (i.e. during the 120 second walk time after the user has pressed the push button) by setting the Device Password ID value to PushButton.
- Have the SSID field set to the P2P Wildcard SSID.
- Have the BSSID field set to the Wildcard BSSID.

Probe Request frames sent by P2P devices in the Search State may include either one of the following:

- Requested Device Type attribute in the WSC IE. This attribute has the same format as the Primary Device Type attribute in the Wi-Fi Protected Setup specification.
- P2P Device ID attribute in the P2P IE.

A P2P Device in Search State that transmits a Discovery DMG Beacon frame may reduce the set of P2P Devices that are allowed to respond in the A-BFT following the BTI where the Discovery DMG Beacon frame is transmitted. To achieve this, the P2P Device shall set the CC Present field to 1 in the Discovery DMG Beacon frame and shall set the A-BFT Responder Address subfield to a known P2P Device Address or to a known P2P Group Address (specifically, the P2P Device Address field of the P2P Group ID attribute). When the A-BFT Responder Address subfield identifies a P2P Group Address, all P2P Devices in the group are allowed to respond during the A-BFT following the BTI where the Discovery DMG Beacon frame is transmitted.

When operating outside DMG, a P2P Device in the Search State shall not reply to Probe Request frames. When operating within DMG, a P2P Device in the Search State may reply to Probe Request frames.

As specified in Section 11.31 of IEEE 802.11-2020 [1], multi-band capable P2P Devices include the Multi-band element as described in IEEE 802.11-2020 [1] in transmitted Probe Request and Probe Response frames. This allows the multi-band capable P2P Device to signal support to more than one frequency band.

As specified in Section 11.1.4.3.3 of IEEE 802.11-2020 [1] when operating within DMG, a P2P Device that is in Search State might have to perform the active scanning procedure described in Section 11.1.3.4 of IEEE 802.11-2020 [1] prior to transmitting Probe Request or Probe Response frames on a channel. Once the P2P Device successfully establishes a beamforming link, the P2P Device transmits Probe Request or Probe Response frames. The P2P Device that performs the procedure described in Section 11.1.3.4 of IEEE 802.11-2020 [1] shall set the BSS Type field within the transmitted DMG Beacon and Probe Response frames to 1 (non-PCP/non-AP DMG STA).

Note – When operating within DMG, a P2P Device that is in Search State can increase the chances of discovering another P2P Device by staying awake longer following the A-BFT.

In-band Device Discovery procedures of a P2P Device operating outside DMG are illustrated in Figure 5. In-band Device Discovery procedures of a P2P Device operating within DMG are illustrated in Figure 6.

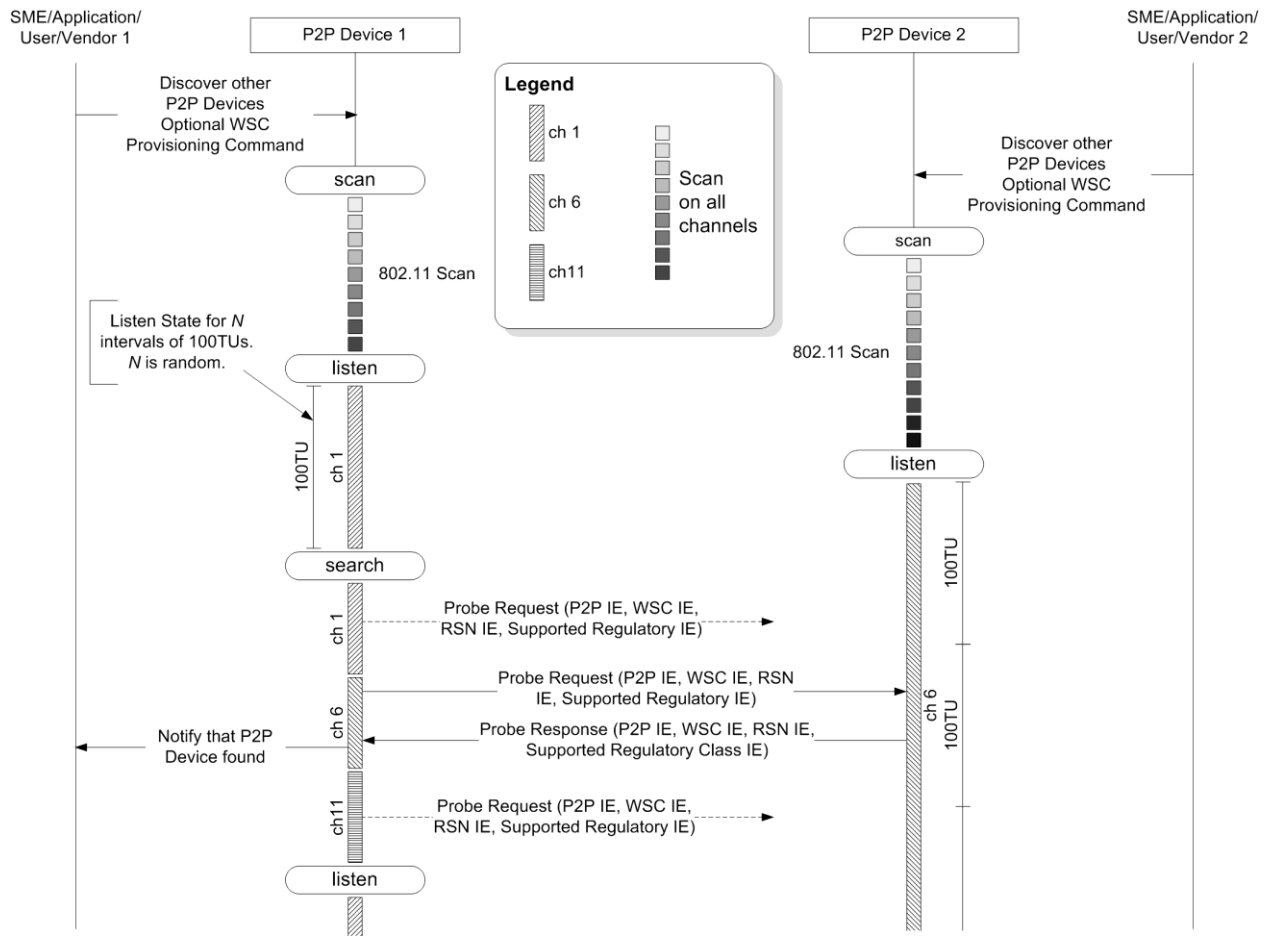

Figure 5—Example In-band Device Discovery procedures for a P2P Device operating outside DMG

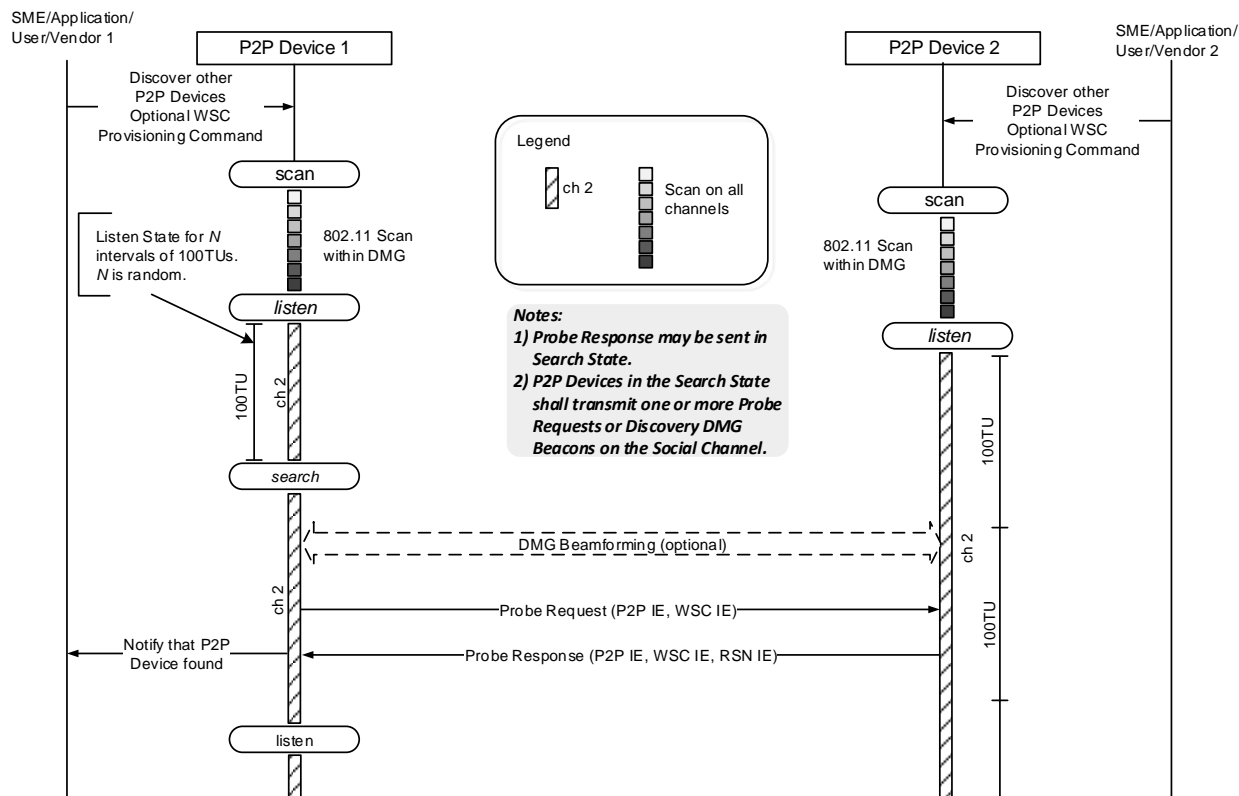

Figure 6—Example In-band Device Discovery procedures for a P2P Device operating within DMG

If a P2P Device operating within DMG successfully completes Device Discovery with a peer P2P Device and decides to proceed with establishing a P2P connection with the peer P2P Device, then all Discovery DMG Beacon frames transmitted following Device Discovery should have the CC Present field equal to 1 and the A-BFT Responder Address field set to the P2P Device Address of the peer P2P Device. This serves to limit the number of P2P Devices that respond in the following A-BFT.

3.1.2.2 P2P Device discovering a P2P Device that is in a P2P Group

A searching P2P Device discovers a P2P Group Owner in the Scan Phase through received Beacon, DMG Beacon, SSW, or Probe Response frames. The searching P2P Device will also discover other P2P Devices that are associated to that P2P Group Owner from Group Information Advertisement (see Section 3.2.4) or, when operating within DMG, through a STA Availability element or Information Response frame (see Section 11.28.1 of IEEE 802.11-2020 [1]).

A searching P2P Device operating outside DMG should be aware that the P2P Group Owner may use P2P power saving and this may impact discoverability of the P2P Group (see Section 3.3.2). A searching P2P Device operating within DMG should be aware that the P2P Group Owner may use power saving as specified in Section 11.2.7.3 of IEEE 802.11-2020 [1] and this may impact discoverability of the P2P Group (see Section 3.3.2).



A searching P2P Device operating outside DMG should be aware that the target P2P Device may use P2P power saving and this may impact communication with the P2P Device. A searching P2P Device operating within DMG should be aware that the target P2P Device may use power saving as specified in Section 11.2.7.2 of IEEE 802.11-2020 [1] and this may impact communication with the P2P Device.

If the target P2P Device is a P2P Client in a P2P Group, a searching P2P Device may send a Device Discoverability Request frame to the P2P Group Owner with the P2P Device ID of the target P2P Device. The P2P Group Owner indicates to the target P2P Device the request to be available for discovery and sends a Device Discoverability Response, as described in Section 3.2.4. If the target P2P Device is making use of power save mechanisms this response may take multiple beacon periods. On reception of a Device Discoverability Response frame that indicates success in the status code the searching P2P Device may attempt to perform Service Discovery or establish a P2P Group with the target P2P Device.

In addition, when operating within DMG, a searching P2P Device may discover the presence or absence of other P2P Clients in the P2P Group by sending an Information Request frame to the P2P Group Owner to solicit an Information Response frame as specified in Section 11.28 of IEEE 802.11-2020 [1]. In the transmitted Information Request frame, the searching P2P Device may also request to obtain the wakeup schedule of the target P2P Client. The wakeup schedule includes the periods of time when the target P2P Client is awake, and hence when Device Discovery or Service Discovery with the target P2P Client can be successful.

A P2P Client may indicate to the P2P Group Owner that it does not currently support P2P Discovery as described in Section 3.2.4.

Information in the P2P Capability attribute may be used to decide whether to attempt to join a P2P Group. If the P2P Group Limit field indicates that more connections are supported then the P2P Device may attempt to join the P2P Group to connect to the P2P Group Owner. If the Intra-BSS Distribution field indicates that communication between P2P Clients is supported then the searching P2P Device may join the P2P Group to communicate with any of the P2P Devices in the P2P Group.

When operating within DMG, the P2P Group Owner shall operate as PCP of the underlying PBSS.

If a P2P Device operating within DMG performs in the role of P2P Group Owner, the P2P Device shall set the P2P Group Owner field within the P2P Capability attribute to 1. Otherwise, this field shall be set to 0.

If a P2P Device desires to join a P2P Group it may do one of the following:

- Use Wi-Fi Protected Setup [2] to obtain Credentials. Wi-Fi Protected Setup will take place on the Operating Channel of the P2P Group Owner.

- If the P2P Device is provisioned, connect to the P2P Group as described in Section 3.2.3.

If a searching P2P Device does not want to join the P2P Group that the discovered P2P Device is a member of, the searching P2P Device may do one of the following:

- Send a P2P Invitation Request frame to request that the target P2P Device joins a P2P Group of which the searching P2P Device is the P2P Group Owner or a P2P Client.
- Send a P2P Invitation Request frame to request that a previously established Persistent P2P Group, of which one of the P2P Devices is the P2P Group Owner, be invoked (see Section 3.1.5).
- Subject to the rules in Section 3.1.4, initiate Group Owner Negotiation to attempt to form a new P2P Group. The P2P Device Limit field bit in the Device Capability Bitmap field of the P2P Capability attribute indicates if the target P2P Device is able to establish an additional P2P connection.

3.1.2.3 Two P2P Devices in discovery

A P2P Device in the Scan Phase may discover a P2P Device in the Listen State. The Find Phase is used to ensure that two P2P Devices that are both in In-band Device Discovery arrive on a common channel to exchange device information. If a P2P Device wishes to connect it may do one of the following:

- Initiate Group Owner Negotiation to attempt to form a new P2P Group.
- Send a P2P Invitation Request frame to request that a previously established Persistent P2P Group, of which one of the P2P Devices is the P2P Group Owner, be invoked (see Section 3.1.5).
- Send a P2P Invitation Request frame to request that the target P2P Device joins a P2P Group of which the searching P2P Device is the P2P Group Owner or a P2P Client. In-band

3.1.2.4 Device Discovery procedures for a P2P Group Owner

A P2P Device that is already operating as a P2P Group Owner stays on the Operating Channel and waits for other devices to discover it. A P2P Group Owner may search on other channels to find desired devices or services.

When operating outside DMG, if the P2P Group Owner is unavailable on the Operating Channel it shall indicate this using the Notice of Absence mechanism as defined in Section 3.3.3.2. When operating within DMG, if a P2P Group Owner is unavailable on the Operating Channel it shall indicate this using the mechanism described in Section 11.2.7.3 of IEEE 802.11-2020 [1].

3.1.2.5 P2P Group Owner enabling discovery for a Legacy Client

The procedures in this Section apply only to operation outside DMG.

A Legacy Client uses the 802.11 scan process as defined in IEEE 802.11-2020 [1] to collect information about surrounding devices or networks. A Legacy Client can only discover a P2P Group Owner. When a P2P Group Owner receives a Probe Request frame from a Legacy Client in its Operating Channel, the P2P Device shall transmit a Probe Response frame as defined in IEEE 802.11-2020 [1] except as noted in Section 2.4.1. The Legacy Client may use the collected information to initiate Wi-Fi Protected Setup [2] in order to connect to the P2P Device.

A Legacy Client that does not support Wi-Fi Protected Setup [2] has to be provisioned using methods outside the scope of this specification. The P2P Group Owner shall generate the Credentials used for provisioning.

3.1.2.6 P2P Device discovering a P2P Device associated with an infrastructure AP

A searching P2P Device may discover a P2P Device associated with an infrastructure AP in the Scan Phase through Probe Response frames. A P2P Device associated with an infrastructure AP receiving a Probe Request frame with a P2P IE and either a wildcard SSID or a P2P wildcard SSID may respond with a Probe Response frame with a P2P IE. A searching P2P Device should be aware that the P2P Device may use power saving and this may impact its discoverability (see Section 3.1.2.2). A P2P Device that is associated with an infrastructure AP shall still need to be in the Listen State for In-band Device Discovery as described in Section 3.1.2.1.1 and Section 3.1.2.1.3.

Information in the P2P Capability attribute, or a Service Discovery exchange may be used to decide whether to attempt to establish a P2P Group as described in Section 3.1.2.2.

If a P2P Device desires to communicate with the discovered device it may do one of the following on the channel of the discovered P2P Device:

- Send a P2P Invitation Request frame to request that the target P2P Device joins a P2P Group of which the searching P2P Device is the P2P Group Owner or a P2P Client.
- Send a P2P Invitation Request frame to request that a previously established Persistent P2P Group, of which one of the P2P Devices is the P2P Group Owner, be invoked (see Section 3.1.5).
- Subject to the rules in Section 3.1.4, initiate Group Owner Negotiation to attempt to form a new P2P Group. The P2P Device Limit field bit in the Device Capability Bitmap field of the P2P Capability attribute indicates if the target P2P Device is able to establish an additional P2P connection.

3.1.2.7 Out-of-Band Device Discovery using NFC

If a user recognizes that both of two P2P Devices support NFC, then the user may initiate NFC Out-of-Band channel for Device Discovery. The NFC Out-of-Band Device Discovery is used to ensure that two P2P Devices:

- Agree on a common channel for GO negotiation for the Group Formation if no suitable group exists.

- Exchange WSC and P2P attributes to allow the devices to form a new group or allow one of the devices to join an existing group.

If using NFC Out-of-Band communication, then a P2P Device or P2P Group Owner shall use NFC Handover Request/Select Message for Out-of-Band Device Discovery. NFC Handover Request/Select Messages are exchanged over the Out-of-Band channel before the Group Formation or P2P Invitation.

Figure 7 shows the example of NFC Out-of-Band Device Discovery using NFC Negotiated Handover between two P2P Devices with NFC Interface.

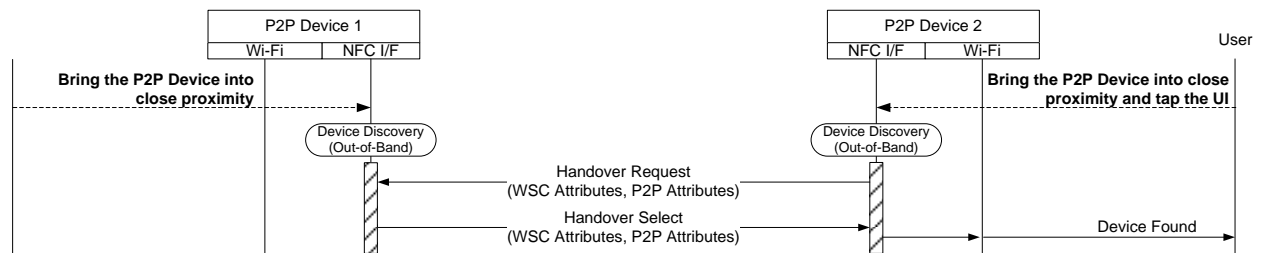

Figure 7—Out-of-Band Device Discovery (NFC Negotiated Handover)

When two P2P Devices which have an NFC Interface are brought into close proximity, they will establish NFC communication based on the NFC Forum Logical Link Control Protocol (LLCP) specification [9]. If one of the devices has intention to activate a further Wi-Fi communication method, it may then use the NFC Forum Connection Handover protocol to announce possible communication means and request the other device to respond with a selection of matching technologies, including necessary WSC and P2P attributes.

When a P2P Device has established NFC-LLCP communication with another P2P Device, it sends a Handover Request Message as described in [9]. Note that in some circumstances both P2P devices may send a Handover Request Message simultaneously, in which case the collision is handled by the Connection Handover protocol as described in [9]. The corresponding P2P Device shall respond to a Handover Request Message with a Handover Select Message.

The Handover Request/Select Messages:

- If the sender is a client of a P2P Group, the Handover Request/Select Messages shall include P2P attributes and shall omit the mandatory WSC attributes of the sender in the P2P Carrier Configuration Record which is defined in Section 4.5.1 or 4.5.2 . Otherwise, both P2P and WSC attributes shall be included in the P2P Carrier Configuration Record.
- Shall include the Out-of-Band Group Owner Negotiation Channel attribute where

- If the device is a GO or client of a P2P Group, the channel information shall be set to the P2P Group's operating channel.
- If the device is a P2P Device, it shall be set to the device's listen channel.
- The Role Indication shall be set as described in 4.1.21.

After completion of NFC Out-of-Band Device Discovery, the two P2P devices shall complete the in-band procedure using one of the following:

- If both P2P devices are not part of a P2P Group, the device that receives the Handover Select Message shall initiate a suitable in-band procedure using the P2P Device Address indicated in the P2P Device Info attribute and the channel indicated in the Out-of-Band Group Owner Negotiation Channel attribute in the Handover Select Message.
- If one P2P device is not part of a P2P Group, and the other is a GO of a P2P Group, the device that is not part of a P2P Group shall start the procedure to join the P2P Group using the P2P Device Address indicated in the P2P Device Info attribute and the channel indicated in the Out-of-Band Group Owner Negotiation Channel attribute contained in either the Handover Request Message or the Handover Select Message sent by the GO. Provision Discovery is not used after NFC Out-of-Band Device Discovery in this case.
- If the P2P Device receiving the Handover Request Message is already a P2P client of an existing P2P Group, as indicated by the Role indication in the Out-of-Band Group Owner Negotiation Channel attribute, then it responds with a P2P Handover Select Message as described in [9] containing the Group Owner's P2P Group ID and Operating Channel attributes, so that the requesting P2P device can find the Group Owner and join the group using a suitable in-band procedure. The mandatory WSC attributes belonging to the P2P device receiving the Handover Request Message shall be omitted in the Handover Select Message; optional WSC attributes may be included to assist with discovering the Group Owner. Whether the NFC Handover Requester chooses to join is left to implementation. However, for better user experience, it should provide an appropriate indication to the user.

A P2P Client may be capable of concurrent operation in an Infrastructure BSS and is also able to handle Alternative Carrier for Wi-Fi Protected Setup [2], in which case it should follow the rules specified therein. See Section 4.4 for more details on how to handle multiple Alternative Carriers.

Figure 8 shows NFC Out-of-Band Device Discovery using NFC Static Handover between the P2P Device with NFC Tag and the P2P Device which supports NFC Interface. Provision Discovery is not used after NFC Out-of-Band Device Discovery in this case.

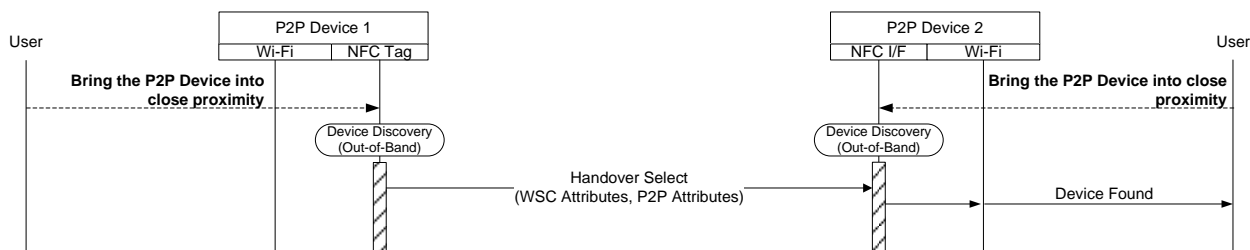

Figure 8—Out-of-Band Device Discovery (NFC Static Handover)

If an NFC Static Handover occurs between a P2P Device with NFC Tag and the P2P Device which supports NFC Interface, NFC Interface shall read the Handover Select Message from the NFC Tag.

The Handover Request/Select Message format and its NDEF record for NFC Out-of-Band Device Discovery is defined in Section 4.5. If the P2P Device uses an NFC Tag, its data capacity shall be large enough to store the Handover Select Message defined in 4.5.2.

Whether the NFC Handover Requester chooses to join is left to implementation. However, for better user experience, it should provide an appropriate indication to the user.

It is recommended that NFC enabled P2P devices should remain discoverable over WLAN to maintain interoperability with devices that do not have the NFC option.

3.1.3 Service Discovery procedures

The Service Discovery procedure is an optional frame exchange that may be performed at any time to any discovered P2P Device, for example following a successful Device Discovery procedure prior to group formation. This procedure can be used to determine compatibility information on the services offered by a P2P Device. This protocol is extensible and flexible so that it enables different higher layer service advertisement protocol types such as Bonjour [4] and UPnP [5].

The Service Discovery procedure leverages the Generic Advertisement Service (GAS) protocol/frame exchange as defined in IEEE 802.11-2020 [1]. The Service Discovery procedure uses GAS with unicast standard public action frames with a vendor specific body. It may be a single or multiple GAS Initial Request and Response action frame exchange. The requesting P2P Device transmits one or more GAS Initial Request frames. A target P2P Device that supports Service Discovery responds with one or more GAS Initial Response frames. It is assumed that service information is readily available within a P2P Device supporting Service Discovery and the GAS Initial Response frame shall be returned without delay after receiving a GAS Initial Request.

The Service Discovery procedure can be used to find:

- A list of all services offered by a P2P Device

- Information about a single service offered by a P2P Device
- Information about multiple services offered by a P2P Device
- If there has been a change in the services offered by a P2P Device

The requested information can be for a single service protocol type, for multiple service protocol types, or for all service protocol types supported by a P2P Device.

The requested information can be associated with the frequency band where the Service Discovery procedure is initiated or with any other frequency band supported by a P2P Device. When the requested information corresponds to a frequency band different than the frequency band where Service Discovery is initiated, one of those frequency bands shall be DMG.

The decision to perform Service Discovery is implementation specific and beyond the scope of this specification.

3.1.3.1 Service Discovery Query

The Service Discovery Query frame uses the GAS Initial Request frame as defined in IEEE 802.11-2020 [1].

The Service Discovery Query frame shall support different query types, which changes the content of the fields in the Vendor-Specific content field.

To request a list of all services of all higher layer (above Layer 2) service protocol types, the Service Discovery Query frame shall include a single Service Request TLV with the Service Protocol Type field equal to 0 and a Query Data length of 0. A Service Transaction ID is included in all Service Request and Response TLVs and is used to match the response to the query.

To request a list of all services of a specific higher layer service protocol type, the Service Discovery Query frame shall include a single Service Request TLV with the Service Protocol Type field set to one of the non-zero values defined in Table 78 and a Query Data length of 0.

To request information about a specific service of a specific higher layer service protocol type, the Service Discovery Query frame shall include a single Service Request TLV with the Service Protocol Type field set to one of the non-zero values defined in Table 78 and the Query Data. The Query Data field shall include the service information type pertaining to the requested Service Protocol Type. The service information type is out of scope of this specification since it is defined by the service protocol being used.

To request information about multiple services of a single or multiple higher layer service protocol types, the Service Discovery Query frame shall include multiple Service Request TLVs. Each Service Request TLV shall contain the Service Protocol Type field set to one of the non-zero values defined in Table 78 and the Query Data. The Query Data field shall include the service information type pertaining to the requested Service Protocol Type.

The Service Update Indicator shall be included in all Service Discovery Query frames. It shall be incremented every time a change occurs in the service information of the P2P Device sending this Service Discovery Query. This allows for a P2P Device to cache service information retrieved from another P2P Device, together with the Service Update Indicator. Whenever a P2P Device notices that the Service Update Indicator for another P2P Device has incremented, it shall know to flush the cached service information for that P2P Device.

To request information about services available in a frequency band other than the frequency band used to transmit the Service Discovery Query frame, the Service Discovery Query frame shall include a Multi-band element as specified in IEEE 802.11-2020 [1].

3.1.3.2 Service Discovery Response

The Service Discovery Response frame uses the GAS Initial Response frame as defined in IEEE 802.11-2020 [1].

Since the Service Discovery Response frame supports different query types, the Vendor-specific content may contain different fields. A Service Transaction ID is included in all Service Request and Response TLVs and is used to match the response to the query.

If the Service Discovery Query frame is for all services and all higher layer service protocol types, the Service Discovery Response frame may contain multiple Service Response TLVs. Each Service Response TLV shall contain the Service Protocol Type (for example, Bonjour, UPnP, etc.) field set to one of the non-zero values defined in Table 78. The Service Transaction ID is set to the value corresponding to the Service Transaction ID in the Service Request TLV. The Status Code field of each returned Service TLV is set to Service available (value 0 in Table 80). The available service information is contained in the Response Data field. The Response Data field shall contain the service information type and service data pertaining to the Service Protocol Type. If no services are available, a single Service Response TLV is returned with the Service Protocol Type field equal to 0, the Status Code field set to an appropriate error code, and a null value (zero length string) in the Response Data field.

If the Service Discovery Query frame is for all services of a specific higher layer service protocol type, the Service Discovery Response frame may contain multiple Service Response TLVs. Each Service Response TLV shall contain the Service Protocol Type field set to the requested service protocol type. The Service Transaction ID is set to the value corresponding to the Service Transaction ID in the Service Request TLV. The Status Code field of each returned Service TLV is set to Service available (value 0 in Table 80). The Response Data field shall contain the service information type and service data of the available service. If no services are available, a single Service Response TLV is returned with the Service Protocol Type field equal to the requested

protocol, the Status Code field set to an appropriate error code, and a null value (zero length string) in the Response Data field.

If the Service Discovery Query frame is for a single service of a specific higher layer protocol type, the Service Discovery Response frame shall contain a single Service Response TLV. The Service Response TLV shall contain the Service Protocol Type field set to the requested service protocol type. The Service Transaction ID is set to the value corresponding to the Service Transaction ID in the Service Request TLV. If the service is available the Status Code field is set to Service available (value 0 in Table 80) and the Response Data field contains the corresponding service information type and service data. If the service is not available the Status Code field is set to the appropriate error status value in Table 80 and the Response Data field is a null value (zero length string)..

If the Service Discovery Query frame contains multiple Service Request TLVs for multiple higher layer services and for one or more service protocol types, the Service Discovery Response frame shall contain multiple Service Response TLVs. At least one Service Response TLV will be returned for each corresponding Service Request TLV identified by the Service Transaction ID. Each Service Response TLV shall contain the Service Protocol Type field set to one of the non-zero values defined in Table 78 corresponding to the requested Service Protocol Type. The Service Transaction ID is set to the value corresponding to the Service Transaction ID in the Service Request TLV. If the service is available the Status Code field is set to Service Available (value 0 in Table 80) and the Response Data field contains the corresponding requested service information type and service data. If the service is not available the Status Code field is set to the appropriate error status value in Table 80 and the Response Data field is a null value (zero length string).

The Service Update Indicator shall be included in all Service Discovery Response frames. It shall be incremented every time a change occurs in the Service Information of the P2P Device sending this Service Discovery Response. This allows for a P2P Device to cache service information retrieved from another P2P Device, together with the Service Update Indicator. Whenever a P2P Device notices that the Service Update Indicator for another P2P Device has incremented, it shall know to flush the cached service information for that P2P Device.

If the Service Discovery Query frame included a Multi-band element, the Service Discovery Response may include a Multi-band element as specified in IEEE 802.11- [1]. If included, the information specified in the Multi-band element transmitted in the Service Discovery Response frame shall correspond to the frequency band specified in the Multi-band element contained in the Service Discovery Query frame.

If the Service Discovery Response frame, with multiple Service Response TLVs, exceeds the GAS Initial Response packet size, then the rules for GAS Fragmentation using GAS Comeback Request and Response shall be used as



defined in IEEE 802.11-2020 [1]. Appendix C.3 provides information on the GAS Fragmentation frames and procedure.

Figure 9 illustrates an example of the exchange of Service Discovery Query and Response frames for Service Discovery when operating outside DMG. Figure 10 illustrates an example of the exchange of Service Discovery Query and Response frames for Service Discovery when operating within DMG.

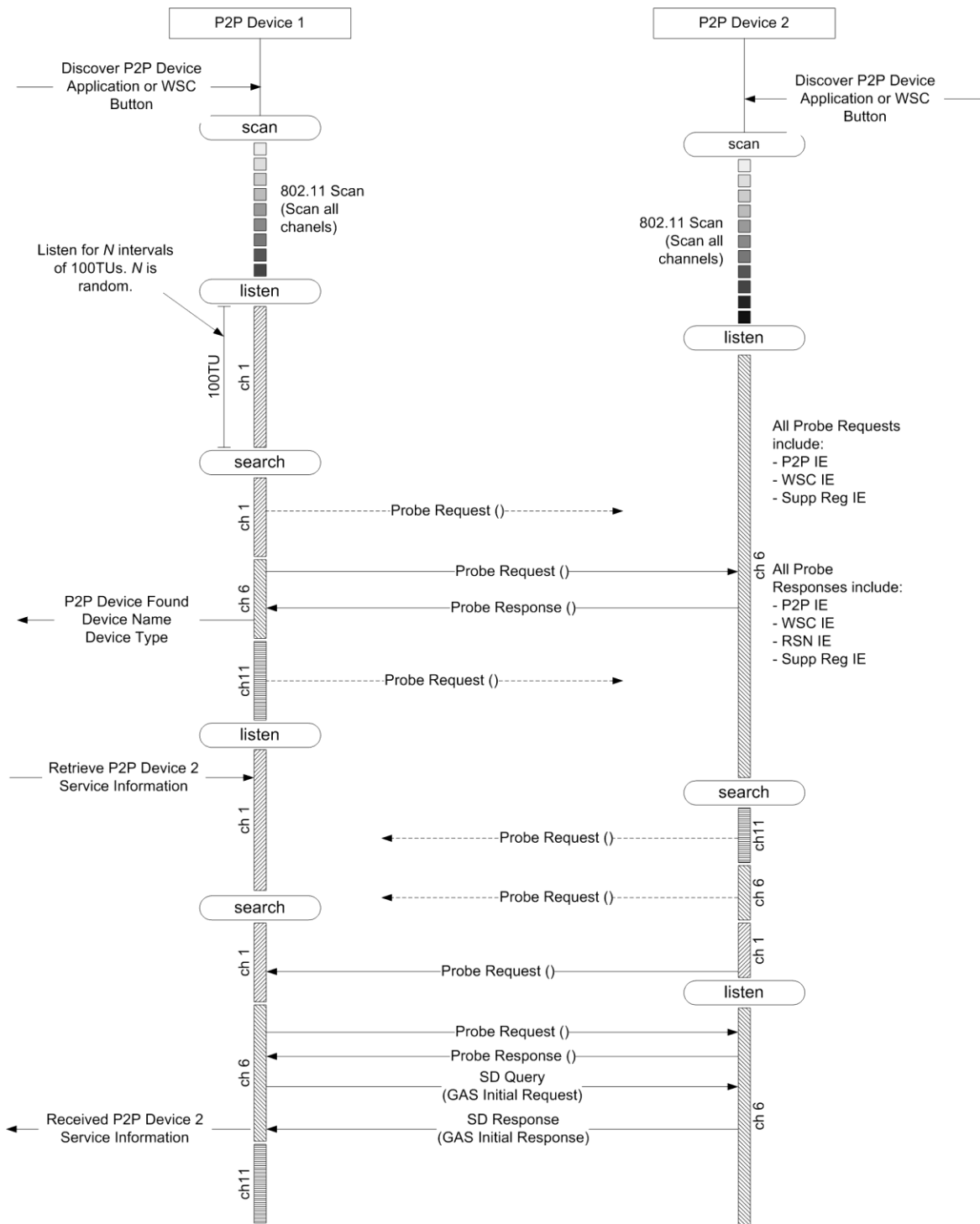

Figure 9—Example of Service Discovery procedure when operating outside DMG

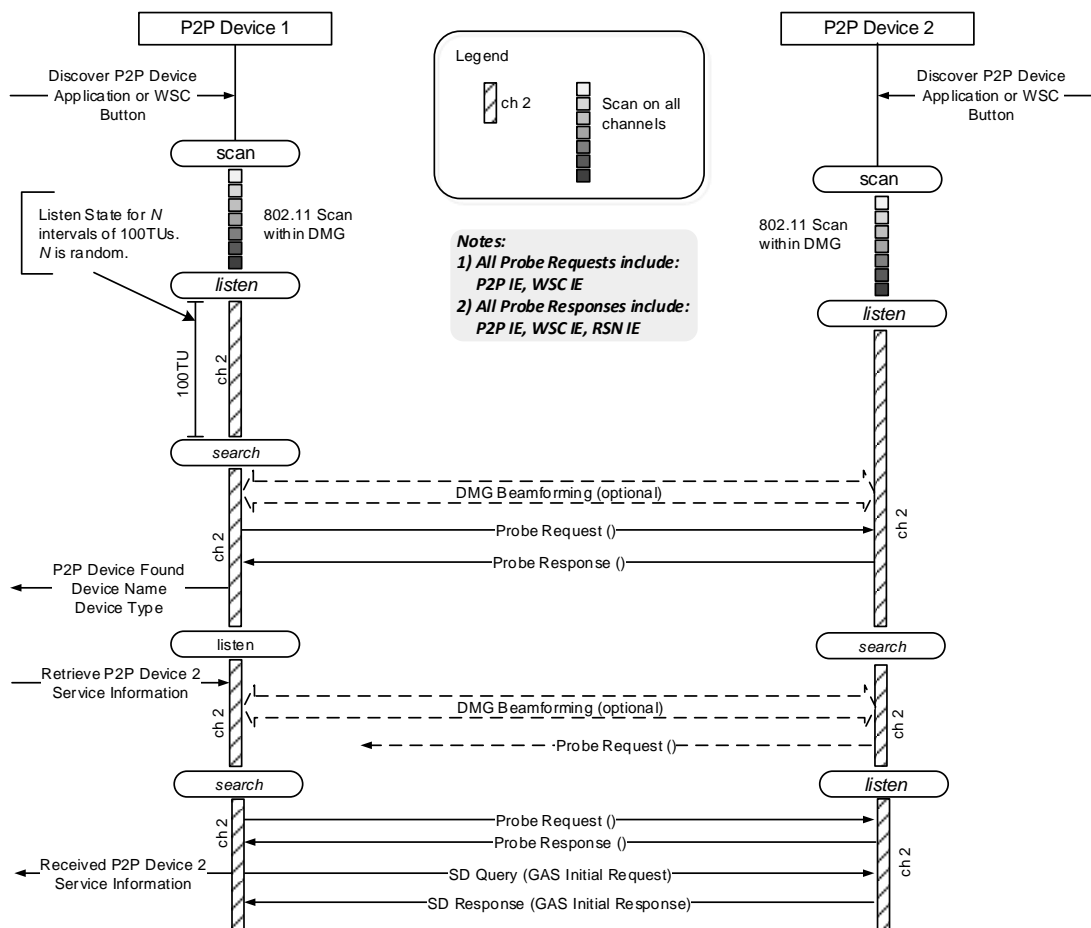

Figure 10—Example of Service Discovery procedure when operating within DMG

3.1.4 Group Formation procedure

3.1.4.1 General procedures

A P2P Device may autonomously start a P2P Group by becoming a P2P Group Owner as described in Section 3.2.2. A P2P Device may use the Group Formation Procedure to form a new P2P Group. Group Formation is used to determine which device shall be the P2P Group Owner, exchange Credentials for the P2P Group and determine its characteristics e.g. whether it shall be a Persistent P2P Group or a Temporary P2P Group. Group Formation Procedure consists of Group Owner Negotiation and Provisioning, as described in the following sections.

Device Discovery (and optional Service Discovery) is intended to determine which P2P Devices may attempt to connect. Device selection may be based on non-unique information, e.g. Device Name, which potentially introduces ambiguity in this process. P2P Device manufacturers should attempt to create unique Device Names and user interfaces that maximize the probability of selecting the correct device, but there will be cases where device selection is non-deterministic. Group Formation uses the authentication provided by Wi-Fi

Protected Setup [2] to determine that the correct devices are connected. Group Formation may need to be executed more than once with different P2P devices to resolve the case of multiple devices with the same Device Name.

Group Formation has a phase called Provisioning that uses Wi-Fi Protected Setup [2] with constraints as described in Section 3.1.4.3. Wi-Fi Protected Setup may take up to two minutes to complete, due to waiting for user input. Since Group Formation may need to execute multiple times, such a delay is unacceptable. A P2P Device shall obtain any information required to execute Provisioning in advance of Group Formation, which includes information such as a PIN that is obtained from a user. A P2P Device shall take no more than fifteen seconds to complete Group Formation.

The P2P Device may use the information supplied in the WSC Config Methods attribute, received in a Probe Response, to determine the appropriate information to retrieve from the user e.g. PIN from a display, etc. A P2P Device may send a Provision Discovery Request with a single method set in the Config Methods attribute with the purpose of triggering some required action at the receiving P2P Device e.g. on reception of this frame a display device may display the required PIN. The Provision Discovery Request frame shall have a single method set in the Config Methods attribute to indicate which of the receiving P2P Device's methods the sending P2P Device intends to use. For example, it shall set the 'Display' method if it intends to use a PIN the receiver shall display. A P2P Device shall respond to a received Provision Discovery Request frame with a Provision Discovery Response frame. The Config Methods attribute in the Provision Discovery Response frame may have the same single method set as in the received Provision Discovery Request frame to indicate success or shall be null to indicate failure.

Table 1 summarizes the valid WSC Config Methods attribute settings in the Provision Discovery exchange and the 'matching' WSC Device Password ID attribute values to be used in Provisioning.

The P2P Group Owner is always the WSC Registrar and the selected PIN (from the display of either the P2P Client or P2P Group Owner) is indicated using Device Password ID attribute in the WSC M1/M2 messages as shown in Table 1.

Note —In contrast, it is common in non-P2P WSC use that the AP PIN is used with reversed Registrar/Enrollee roles, i.e., a STA connecting to the AP acts as a Registrar and uses the AP PIN (which is the Enrollee Device Password in this reversed-role case).



Table 1—Summary of WSC Config Methods and Device Password ID usage

Requestor	Provision Discovery Request	Provision Discovery Response	GO Negotiation Request	GO Negotiation Response	Requestor becomes Client (Enrollee)	Requestor becomes GO (Registrar)
	Config Methods		Device Password ID		Device Password ID in M1/M2	Device Password ID in M1/M2
Displays PIN	Keypad	Keypad	Registrar-specified	User-specified	Default (PIN)	Registrar Specified
Enters PIN	Display	Display	User-specified	Registrar-specified	Registrar Specified	Default (PIN)
Uses pushbutton	PushButton	PushButton	PushButton	PushButton	PushButton	PushButton
NFC	NFC Interface or External/Integrated NFC Tag	NFC Interface or External/Integrated NFC Tag	Password ID taken from Out-of-Band Device Password attribute	Password ID taken from Out-of-Band Device Password attribute	Password ID taken from Out-of-Band Device Password attribute	Password ID taken from Out-of-Band Device Password attribute

When a P2P Device discovers another P2P Device with which it intends to connect, it may start the Group Formation Procedure. A P2P Device shall conduct the Group Formation Procedure with one other P2P Device. The Group Formation Procedure shall complete prior to entering the Group Formation Procedure with any other P2P Device. A P2P Device that is already in Group Formation, and receives a GO Negotiation Request frame from a device with which it is not in Group Formation, shall respond with a GO Negotiation Response frame indicating failure (see Section 3.1.4.2.2).

Prior to beginning the Group Formation Procedure the P2P Device shall arrive on a common channel with the target P2P Device. The Find Phase in In-band Device Discovery or Out-of-Band Device Discovery may be used for this purpose. In the former case, the P2P Device only needs to scan the Listen Channel of the target P2P Device, as opposed to all of the Social Channels. This use of the Find Phase is to recover from the case where the two P2P Devices may simultaneously move to the Listen Channel of the other device and thus miss each other’s Probe Requests, DMG Beacon, or SSW frames. A P2P Device may start Group Owner Negotiation by sending a GO Negotiation Request frame after receiving a Probe Request frame from the target P2P Device.

When the P2P Devices arrive on a common channel and begin Group Owner Negotiation, they shall stay on that channel until Group Owner Negotiation completes. Group Formation begins with the Group Owner Negotiation and completes with Provisioning as described in Section 3.1.4.3.

3.1.4.2 Group Owner Negotiation

Group Owner Negotiation is a three way frame exchange used to agree which P2P Device shall become P2P Group Owner and to agree on characteristics of the P2P Group, as illustrated in Figure 11. The details of those three frames are described in the following sections.

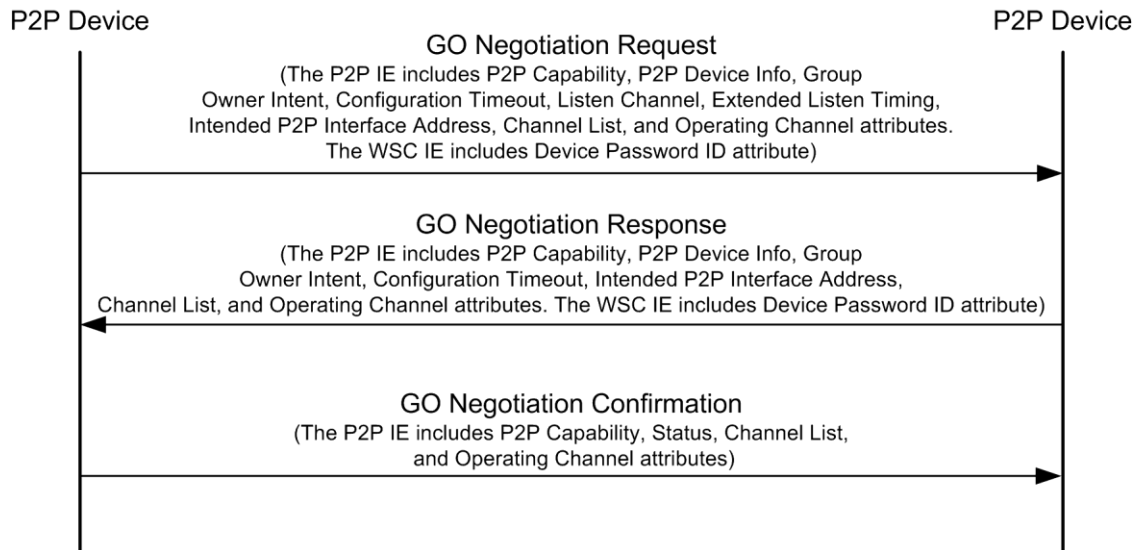

Figure 11—Group Owner Negotiation message exchange

A P2P Device may choose not to respond to a Group Owner Negotiation frame due to reasons beyond the scope of this specification. The P2P Device that sent the Group Owner Negotiation frame shall assume that Group Owner Negotiation failed and is complete if it does not receive the next frame in the exchange within 100 milliseconds of receiving an acknowledgment frame. Either P2P Device may initiate Group Formation between these same P2P Devices again at a later time.

A primary purpose of Group Owner Negotiation is to exchange the Group Owner Intent attribute to communicate a measure of desire to be P2P Group Owner. If the P2P Device must be the P2P Group Owner, the Intent field in the Group Owner Intent attribute shall be set to 15. The Group Owner Intent attribute should only be set to 15 when a configuration or service will only operate correctly at a P2P Group Owner; for instance, a P2P Device that is offering cross connection shall set its Intent value to 15.

NOTE – When operating within DMG, PCP selection (see Section 11.1.4.3.10 of IEEE 802.11-2020 [1]) takes place once the GO has been selected, i.e., possibly after additional frame exchanges after the exchange of Probe Request and Probe Response frames during Device Discovery.

The Tie breaker bit in a first GO Negotiation Request frame (for instance after power up) shall be set to 0 or 1 randomly, such that both values occur equally

on average. On subsequent GO Negotiation Request frames except retransmissions, the Tie breaker bit shall be toggled. The Tie breaker bit in a GO Negotiation Response frame shall be toggled from the corresponding GO Negotiation Request frame.

If the Intent values in the GO Negotiation Request and Response frames are equal and less than 15, then the device sending the Tie breaker bit equal to 1 becomes the GO.

Group Owner determination is depicted in Figure 12.

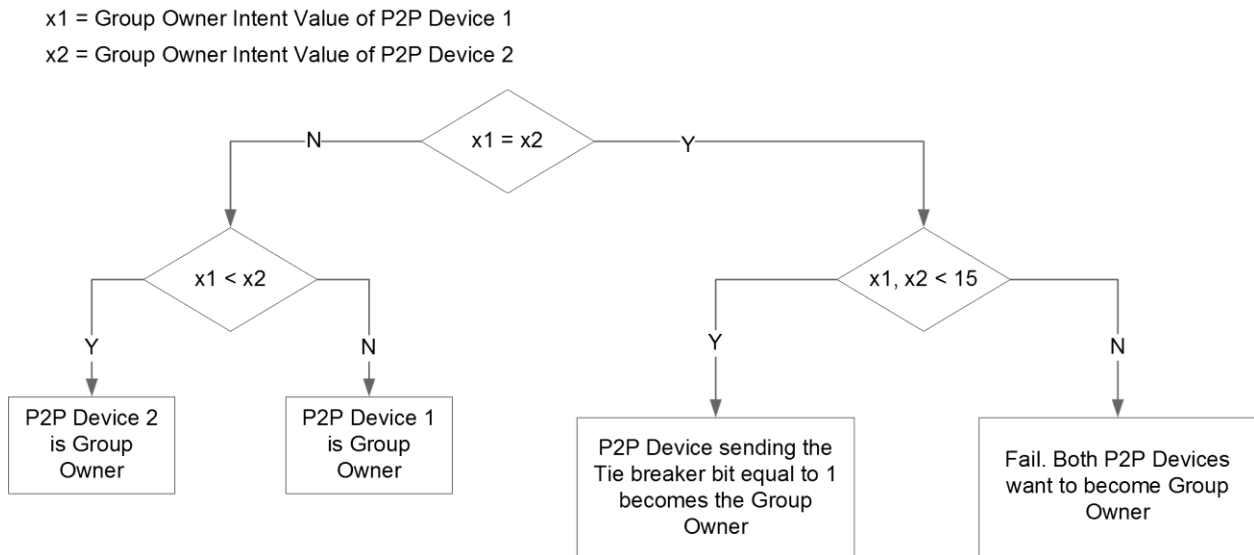

Figure 12—Group Owner determination flowchart

3.1.4.2.1 GO Negotiation Request

A P2P Device shall initiate Group Owner Negotiation by sending the GO Negotiation Request frame. The GO Negotiation Request frame shall include a P2P IE with the P2P Capability, P2P Device Info, Channel List, Listen Channel, Operating Channel, Group Owner Intent, Configuration Timeout and Intended P2P Interface Address attributes and a WSC IE with the Device Password ID attribute.

The Group Capability Bitmap field in the P2P Capability attribute indicates the characteristics of the P2P Group to be formed if the P2P Device sending the GO Negotiation request becomes Group Owner.

The Channel List attribute shall indicate the channels that the P2P Device can support as Operating Channel of the P2P Group if it becomes P2P Group Owner. The Operating Channel attribute includes a preferred Operating Channel. See Section 3.4.2 for additional rules on channel selection.

The Configuration Timeout attribute contains the maximum time that the P2P Device needs after completion of Group Owner Negotiation to be available to

start Provisioning. The Intended P2P Interface Address attribute contains the P2P Interface Address that the P2P Device shall use during Provisioning if Group Owner Negotiation succeeds.

The Device Password ID attribute shall indicate the source of the Provisioning information that the P2P Device shall use in the WSC procedure. If the Provisioning information is a PIN from a display of the sending device the value shall be 'Registrar-specified'. If the Provisioning information is a PIN that was entered by a user of the sending device, the value shall be 'User-specified'. If the sending P2P Device is using the pushbutton method the value shall be 'PushButton'.

3.1.4.2.2 GO Negotiation Response

The P2P Device receiving a GO Negotiation Request frame shall examine the received information and respond with a GO Negotiation Response frame.

The P2P Device shall indicate its intent to enter Group Formation by sending a GO Negotiation Response frame that indicates a Status of Success. The GO Negotiation Response frame shall include a P2P IE with the P2P Capability, Status, P2P Device Info, Channel List, Operating Channel, Group Owner Intent, Configuration Timeout and Intended P2P Interface Address attributes and a WSC IE with the Device Password ID attribute.

A P2P Device may decline Group Owner Negotiation for any reason and shall send a GO Negotiation Response frame with the Status Code set to one of the "fail" codes in the Status attribute, as defined in Table 8.

A P2P Device that does not have the Provisioning information shall respond with a GO Negotiation Response frame that includes the Status attribute with the Status Code field set to "Fail; information is currently unavailable". If Provisioning information becomes available as a result of user input (Pushbutton, or Keypad Config Methods) within 120 seconds, the P2P Device shall restart Group Formation by sending a GO Negotiation Request frame to the requesting P2P Device. If the user input within this time window is to explicitly reject the Group Formation request, the P2P Device shall take no further action. A requesting P2P Device can assume that there will be no attempt to restart Group Formation if it does not receive a GO Negotiation Request frame within 120 seconds of receiving the GO Negotiation Response with Status Code "Fail: information is currently unavailable".

A P2P Device that is already in Group Formation that receives a GO Negotiation Request frame from a P2P Device with which it is not in Group Formation, shall respond with a GO Negotiation Response frame that includes the Status attribute with the Status Code field set to "Fail; unable to accommodate request".

If a P2P Device that must be P2P Group Owner (i.e. that P2P Device would indicate an Intent value of 15) receives GO Negotiation Request frame that also contains an Intent value of 15, the P2P Device shall respond with a GO

Response frame containing a Status attribute with the Status Code field set to “Fail: both P2P Devices indicated an Intent of 15 in Group Owner Negotiation”.

Group Formation ends on transmission or reception of a GO Negotiation Response frame with the Status Code set to a value other than Success. A P2P Device may either subsequently enter, or continue Group Formation with other P2P Devices. Either P2P Device may initiate Group Formation between these same P2P Devices again at a later time.

Two P2P Devices that have discovered each other may send a GO Negotiation Request frame to the other. In this case only the P2P Device with the highest P2P Device Address shall send a GO Negotiation Response frame. If both P2P Devices have indicated an Intent value of 15, the P2P Device with the highest P2P Device Address shall send the GO Negotiation Response frame indicating failure as above.

If the Status is Success the Group Owner Intent attribute included in the GO Negotiation Response frame shall indicate its Intent value to be a Group Owner. The interpretation of P2P IE fields in the GO Negotiation Response frame depends on whether the P2P Device will become P2P Group Owner on successful completion of Group Formation.

A P2P Device that will become the P2P Group Owner constructs the GO Negotiation Response frame corresponding to the following rules. The Channel List attribute shall indicate the channels that the P2P Device may use as Operating Channel of the P2P Group. The channels indicated in the Channel List shall only include channels from the Channel List attribute in the GO Negotiation Request frame. The Operating Channel attribute shall indicate the intended Operating Channel of the P2P Group. The channel indicated in the Operating Channel attribute shall be one of the channels in the Channel List attribute in the GO Negotiation Response frame. The P2P Group ID attribute shall contain the intended SSID of the P2P Group. The Group Capability Bitmap field in the P2P Capability attribute shall indicate the characteristics of the P2P Group to be formed. The Persistent P2P Group, Intra-BSS Distribution, Cross Connection and Persistent Reconnect bits in the Group Capability Bitmap field in the P2P Capability attribute in Beacon and Probe Response frames transmitted by the P2P Group Owner of the P2P Group formed, shall be the same as within the Group Capability Bitmap field in the P2P Capability attribute in the GO Negotiation Response frame.

A P2P Device that will become a P2P Client constructs the GO Negotiation Response frame corresponding to the following rules. The Channel List attribute shall indicate the channels that the P2P Device can support as Operating Channel of the P2P Group. The channels indicated in the Channel List may be determined independently from the channels in the Channel List attribute in the GO Negotiation Request frame. The Operating Channel attribute may indicate a preferred Operating Channel of the P2P Group, or may be omitted. Any channel indicated in the Operating Channel attribute shall be one of the channels in the Channel List attribute in the GO Negotiation Response frame. All bits in the

Group Capability Bitmap field of the P2P Capability attribute shall be reserved. A P2P Device may decline Group Owner Negotiation if the characteristics of the P2P Group indicated in the Group Capability Bitmap field of the P2P Capability attribute in the GO Negotiation Request frame are not acceptable e.g. this will be a Persistent P2P Group and it cannot support a Persistent P2P Group, as defined in 3.2.5. In this case, the P2P Device shall send a GO Negotiation Response frame with the Status Code set to “Fail; incompatible parameters”.

The Configuration Timeout attribute contains the maximum time that the P2P Device needs after completion of Group Owner Negotiation to be available to start Provisioning. The Intended P2P Interface Address attribute contains the P2P Interface Address that the P2P Device shall use during Provisioning if Group Owner Negotiation succeeds.

The Device Password ID attribute included in the WSC IE shall indicate the source of the Provisioning information that the P2P Device shall use. If the Provisioning information is a PIN from a display of the sending device the value shall be ‘Registrar-specified’. If the Provisioning information is a PIN that was entered by a user of the sending device the value shall be ‘User-specified’. If the sending P2P Device is using the pushbutton method the value shall be ‘PushButton’.

A P2P Device may decline Group Owner Negotiation if the Device Password ID in the GO Negotiation Request is incompatible with the information it shall use to execute Provisioning. In this case, the P2P Device shall send a GO Negotiation Response frame with the Status Code set to “Fail; incompatible provisioning method”.

3.1.4.2.3 GO Negotiation Confirmation

Upon receipt of the GO Negotiation Response frame with a Status Code indicating Success, the P2P Device shall examine the received information, and respond with a GO Negotiation Confirmation frame. The Status attribute included in the GO Negotiation Confirmation frame shall indicate whether the GO Negotiation succeeds or fails. It may fail for any reason; typical reasons may be lack of commonly available channel, incompatible parameters related to settings in the Group Capability Bitmap field of the P2P Capability attribute, etc.

If the Status is Success the interpretation of fields in the GO Negotiation Confirmation frame depends on whether the P2P Device that sent the frame will become P2P Group Owner on successful completion of Group Formation.

A P2P Device that will become the P2P Group Owner constructs the GO Negotiation Confirmation frame corresponding to the following rules. The Channel List attribute shall indicate the channels that the P2P Device may use as Operating Channel of the P2P Group. The channels indicated in the Channel List shall only include channels from the Channel List attribute in the GO Negotiation Response frame. The Operating Channel attribute shall indicate the intended Operating Channel of the P2P Group. The channel indicated in the Operating Channel attribute shall be one of the channels in the Channel List

attribute in the GO Negotiation Confirmation frame. The P2P Group ID attribute shall contain the intended SSID of the P2P Group. The Group Capability Bitmap field in the P2P Capability attribute shall be the same as in the GO Negotiation Request frame. The Persistent P2P Group, Intra-BSS Distribution, Cross Connection and Persistent Reconnect bits in the Group Capability Bitmap field in the P2P Capability attribute in the beacon of the group formed shall be the same as within the Group Capability Bitmap field in the P2P Capability attribute in the GO Negotiation Confirmation frame.

A P2P Device that will become a P2P Client constructs the GO Negotiation Confirmation frame corresponding to the following rules. The Channel List attribute shall indicate the channels that the P2P Device can support as Operating Channel of the P2P Group. The channels indicated in the Channel List shall only include channels from the Channel List attribute in the GO Negotiation Response frame and shall include the channel indicated in the Operating Channel attribute in the GO Negotiation Response frame. The Operating Channel attribute in the GO Negotiation Confirmation frame shall be the Operating Channel attribute from the GO Negotiation Response frame. All bits in the Group Capability Bitmap field of the P2P Capability attribute shall be reserved. A P2P Device may decline Group Owner Negotiation if the characteristics of the P2P Group indicated in the Group Capability Bitmap field of the P2P Capability attribute in the GO Negotiation Response frame are not acceptable e.g. this will be a Persistent P2P Group and it cannot support a Persistent P2P Group, as defined in 3.2.5. In this case, the P2P Device shall send a GO Negotiation Confirmation frame with the Status Code set to “Fail; incompatible parameters”.

A P2P Device may decline Group Owner Negotiation if the Device Password ID in the GO Negotiation Response is incompatible with the Provisioning information it shall use to execute Provisioning. In this case, the P2P Device shall send a GO Negotiation Confirmation frame with the Status Code set to “Fail; incompatible provisioning method”.

3.1.4.3 Provisioning

To allow for P2P Device configuration, P2P Devices may delay starting the Provisioning phase until the expiration of the maximum of the P2P Group Owners GO Configuration Time and the P2P Clients Client Configuration Time from the respective Configuration Timeout attributes exchanged during Group Owner Negotiation.

The P2P Device selected as P2P Group Owner during Group Owner Negotiation shall start a P2P Group session as described in Section 3.2.2 using the Credentials it intends to use for that group. The P2P Group Owner shall use the Operating Channel indicated during Group Owner Negotiation, if available. The P2P Client shall connect to the P2P Group Owner to obtain Credentials. If the Operating Channel is not available the P2P Group Owner shall use another channel from the Channel List attribute sent in the GO Negotiation Confirmation frame. The P2P Client may have to scan to find the P2P Group Owner if the



intended Operating Channel is not available. The Group Formation bit in the P2P Group Capability Bitmap of the P2P Capability attribute shall be set to 1 until Provisioning succeeds.

Provisioning shall be executed as described in Wi-Fi Protected Setup [2] with the following modifications:

- The P2P Group Owner shall serve the role as the AP with Internal Registrar for operation outside DMG and shall serve the role as the PCP with Internal Registrar for operation within DMG. It shall only allow association by the P2P Device that it is currently in Group Formation with. Since the user has entered the WSC PIN or triggered the WSC PushButton functionality on both devices, the Registrar shall send M2 in response to M1 and shall not send M2D.
- The P2P Client shall serve the role as the STA Enrollee. It shall associate to the P2P Device that it is currently in Group Formation with.

P2P Devices that have either a keypad or display shall support WSC PIN and pushbutton. P2P Devices that have neither keypad nor display shall support WSC pushbutton. P2P Devices shall not use WSC Label Configuration Method with other P2P Devices.

If Provisioning fails then Group Formation ends and the P2P Group Owner shall end the P2P Group session as described in Section 3.2.9. If Provisioning fails the P2P Device may retry Group Formation or return to Device Discovery.

On successful completion of Provisioning the P2P Group Owner shall set the Group Formation bit in the P2P Group Capability Bitmap of the P2P Capability attribute to 0. At this point the P2P Client may join the P2P Group using the Credentials supplied during Provisioning.

3.1.4.4 Group Formation using Out-of-Band Device Discovery

When a P2P Device discovers another P2P Device with which it intends to connect using an optional Out-of-Band Device Discovery, it may start the Group Formation Procedure. A P2P Device shall conduct the Group Formation Procedure with one other P2P Device over the common channel specified in the Group Owner Negotiation channel attribute as shown in Figure 13.

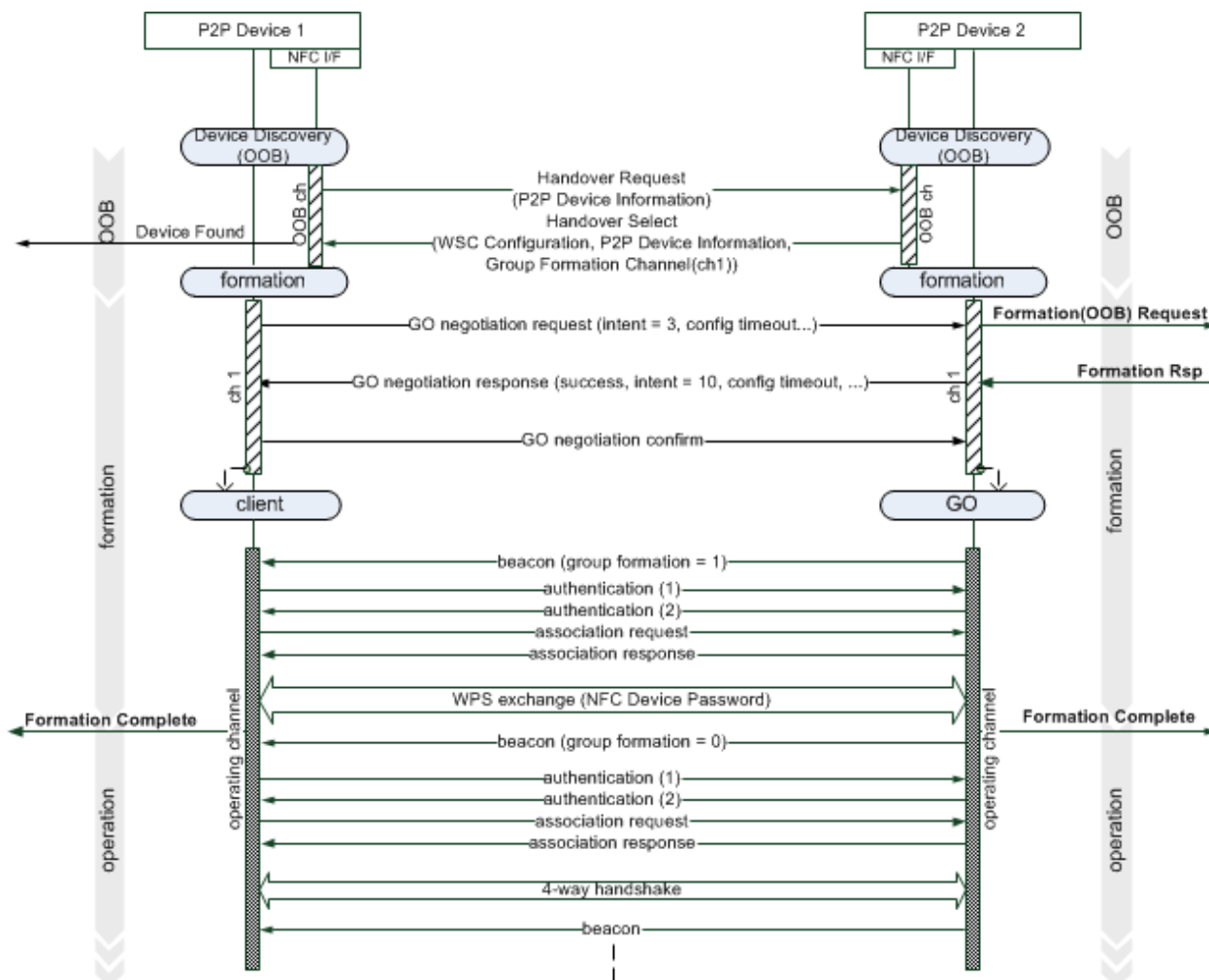

Figure 13—Example of Group Formation using NFC Out-of-Band Device Discovery

3.1.5 P2P Invitation procedure

The P2P Invitation Procedure is an optional procedure used for the following:

3. A P2P Group Owner inviting a P2P Device to become a P2P Client in its P2P Group.
4. A P2P Client inviting another P2P Device to join the P2P Group of which the P2P Client is a member because it wishes to use some service of the P2P Device.
5. Requesting to invoke a Persistent P2P Group for which both P2P Devices have previously been provisioned and one of the Devices is P2P Group Owner for the Persistent P2P Group.

A P2P Device that is invited to join an operational P2P Group through successful completion of the P2P Invitation Procedure, i.e. (1) or (2) above, may:

- Use Wi-Fi Protected Setup [2] to obtain Credentials. Provision Discovery and Wi-Fi Protected Setup will take place on the Operating Channel of the P2P Group Owner.
- If the P2P Device is provisioned, connect to the P2P Group as described in Section 3.2.3.

3.1.5.1 P2P Invitation Request

A P2P Invitation Request frame may be transmitted by:

- A P2P Device that is a member of a P2P Group (i.e. P2P Group Owner or P2P Client) to another P2P Device that supports P2P Invitation Procedure signaling and is currently not a member of the P2P Group to invite that P2P Device to join the P2P Group. When used for this purpose, the Invitation Type in the Invitation Flags attribute included in the P2P Invitation Request frame shall be set to 0.
- A P2P Device that is a member of a Persistent P2P Group to another member of that P2P Group and one of the Devices is the P2P Group Owner, to request that the P2P Group be invoked. When used for this purpose, the Invitation Type in the Invitation Flags attribute included in the P2P Invitation Request frame shall be set to 1.

The contents of the P2P Invitation Request frame depend on the role of the sending device in the P2P Group (in the case of requesting to invoke a Persistent P2P Group, the role of the device in that Persistent P2P Group).

A P2P Invitation Request frame transmitted by a P2P Group Owner shall include the P2P Group ID, P2P Group BSSID, Channel List, Operating Channel, and Configuration Timeout attributes in the P2P IE. The Channel List attribute shall indicate the channels that the P2P Device can support as Operating Channel of the P2P Group. The Operating Channel and Configuration Timeout attributes shall be set as follows:

- If the P2P Invitation Request frame is transmitted by a P2P Group Owner inviting a P2P Device to become a P2P Client in its P2P Group, the Operating Channel attribute indicates the Operating Channel of the P2P Group. The GO Configuration Timeout field in the Configuration Timeout attribute shall be set to 0.
- If the P2P Invitation Request frame is transmitted by a P2P Device requesting to invoke a Persistent P2P Group of which it is P2P Group Owner, the Operating Channel attribute indicates the intended Operating Channel of the P2P Group. The Configuration Timeout attribute shall indicate the configuration time required for the P2P Group Owner to start the P2P Group session after a P2P Invitation Response that indicates success.

If a P2P Group Owner is transmitting the Invitation Request frame after NFC Static Handover, and intends to use the Device Password read from the NFC Tag in the subsequent WSC exchange, then it also shall include a WSC IE in its

P2P Invitation Request and places the Device Password ID read from the NFC Tag in a Device Password ID attribute within the WSC IE.

A P2P Invitation Request frame transmitted by a P2P Client shall include the P2P Group ID, Channel List and Configuration Timeout attributes. The Channel List attribute shall indicate the channels that the inviting P2P Device can support as Operating Channel of the P2P Group. An Operating Channel attribute may also be included: rules for inclusion of the Operating Channel attribute and setting of the Configuration Timeout attribute are as follows:

- If the P2P Invitation Request frame is transmitted by a P2P Client inviting a P2P Device to join the P2P Group of which it is a member, P2P Group BSSID and Operating Channel attributes shall also be present, indicating the BSSID and Operating Channel of the P2P Group, respectively. The Client Configuration Timeout field in the Configuration Timeout attribute shall be set to 0.
- If the P2P Invitation Request frame is transmitted by a P2P Device requesting to invoke a Persistent P2P Group in which it is a P2P Client, an Operating Channel attribute may be present to indicate a preferred Operating Channel. The Configuration Timeout attribute shall indicate the configuration time required to the point that the P2P Client is ready to join the P2P Group after a P2P Invitation Response that indicates success. The P2P Device that sent the P2P Invitation Request frame shall assume that process failed if it does not receive a P2P Invitation Response frame within 100 milliseconds of issuing the P2P Invitation Request frame.

3.1.5.2 P2P Invitation Response

A P2P Device that receives a P2P Invitation Request frame and supports the P2P Invitation Procedure signaling shall return a P2P Invitation Response frame. If the P2P Device accepts the invitation it shall set the Status attribute in the response to success. If the P2P Device does not accept the invitation it shall set the Status attribute to the appropriate failure code. The decision to accept or deny the P2P Invitation Request frame is left to P2P Device's implementation policy.

A P2P Invitation Response frame (with the Status attribute set to Success) transmitted by the P2P Group Owner of a Persistent P2P Group in response to a request to invoke that P2P Group, shall include the P2P Group BSSID, Channel List, Operating Channel and Configuration Timeout attributes to indicate the Group BSSID, potential Operating Channels, intended Operating Channel and any GO Configuration Time. The channels in the Channel List shall only include channels from the Channel List attribute in the P2P Invitation Request frame. The channel indicated in the Operating Channel attribute shall be one of the channels in the Channel List attribute. In the case where there are no channels commonly supported by the P2P Devices the P2P Invitation Response frame shall include a Status attribute with the Status Code field set to "Fail; no common channels".

A P2P Invitation Response frame (with the Status attribute set to Success) transmitted by an invited P2P Client or the P2P Device that is a P2P Client in a Persistent P2P Group, shall include the Channel List and Configuration Timeout attributes. The Channel List indicates the Operating Channels the P2P Client can support. The channels in the Channel List shall only include channels from the Channel List attribute in the P2P Invitation Request frame. The Configuration Timeout attribute shall indicate the configuration time required to the point that the P2P Client is ready to join the P2P Group after a P2P Invitation Response that indicates success. In the case where there are no channels commonly supported by the P2P Devices, or the current operating channel is not supported by the responding P2P Client, the P2P Invitation Response frame shall include a Status attribute with the Status Code field set to “Fail; no common channels”.

The invited P2P Device may also pass the invitation request to a higher layer. In this case it shall respond with a P2P Invitation Response frame with a Status attribute with the Status Code field set to “Fail: information is currently unavailable”. The invited P2P Device shall not wait for any action from a higher layer to send the P2P Invitation Response frame. The P2P attributes returned in the P2P Invitation Response frame shall be as previously described for ‘Success’, with the exception that inclusion of the Operating Channel attribute is optional when the P2P Invitation Response frame is sent by the P2P Group Owner of a Persistent P2P Group in response to a request to invoke that P2P Group. The Configuration Timeout attribute returned in the P2P Invitation Response frame shall be ignored by the inviting P2P Device.

A P2P Device that receives an Invitation Request frame with an Invitation Type in the Invitation Flags attribute set to 1, indicating a request to re-invoke a Persistent Group, and an unknown P2P Group ID, shall respond with an Invitation Response frame with a Status attribute with the Status Code field set to “Fail: unknown P2P Group”.

A P2P Client that has an NFC Tag, supports NFC Static Handover and which receives an Invitation Request from a P2P Group Owner that contains a WSC IE with a Device Password ID attribute, shall compare the Device Password ID from the WSC IE with the Device Password ID from its NFC Tag. If the Device Password IDs match, then the P2P Client may proceed to join the P2P Group and use the Device Password ID and Device Password from its Tag in the subsequent WSC exchange.

3.1.5.3 Use of the Invitation Procedure to invoke a Persistent P2P Group.

A P2P Group Owner may invoke a Persistent P2P Group at any time by starting a P2P Group session as described in Section 3.2.2. Optionally, it may choose to only start the P2P Group session after a successful P2P Invitation Request and Response frames exchange with a member of that P2P Group. In such a case, the P2P Group can only be invoked by P2P Devices that support the P2P Invitation Procedure signaling. Thus all P2P Devices that are capable of

supporting Persistent P2P Groups shall support the P2P Invitation Procedure signaling.

A P2P Client that desires to invoke a Persistent P2P Group shall first discover the P2P Device that is the P2P Group Owner for this Persistent P2P Group and then successfully complete a P2P Invitation exchange with that device. The Invitation Type in the Invitation Flags attribute included in the Invitation Request frame in this exchange shall be set to 1.

A P2P Device that receives an Invitation Request frame to re-invoke a Persistent Group shall ignore the Config Methods field in the P2P Device Info attribute.

A P2P Device that receives an Invitation Request frame to re-invoke a Persistent Group and responds with a P2P Invitation Response frame with a Status attribute with the Status Code field set to “Fail: information is currently unavailable” shall behave as follows:

- If a response is received from higher layers within 120 seconds (e.g. as a result of user input) authorizing the request, the invited P2P Device shall restart the Invitation procedure by sending an Invitation Request frame to the requesting P2P Device.
- If the higher-layer response within this time window is to explicitly reject the Group Formation request, the invited P2P Device shall take no further action.

The requesting P2P Device can assume that there will be no attempt to restart the Invitation Procedure if it does not receive an Invitation Request frame within 120 seconds of receiving the Invitation Response with Status Code “Fail: information is currently unavailable”.

To allow for P2P Device configuration, P2P Devices that are reinvoking a P2P Group may delay starting the P2P Group session until the expiration of the maximum of the P2P Group Owners GO Configuration Time and the P2P Clients Client Configuration Time from the respective Configuration Timeout attributes exchanged during P2P Invitation.

If the P2P Client does not detect the presence of the P2P Group Owner on the intended Operating Channel it shall scan the channels in the Channel List in the P2P Invitation Response frame. The P2P Group Owner may be operating on a different channel, for example if the intended Operating Channel is not available when the P2P Group is invoked.

3.2 P2P Group operation

P2P Group operation outside DMG closely resembles infrastructure BSS operation as defined in IEEE 802.11-2020 [1] with the P2P Group Owner assuming the role of the AP and the P2P Client assuming the role of the STA. The similarities and differences between infrastructure BSS and P2P Group operation outside DMG are described in this section.



P2P Group operation within DMG follows PBSS operation as defined in IEEE 802.11-2020 [1] with the P2P Group Owner operating as the PCP and the P2P Client operating as a non-PCP/non-AP STA. Additional mechanisms applicable to P2P Group operation within DMG are described in this section.

3.2.1 P2P Group ID

The P2P Group Owner shall assign a globally unique P2P Group ID for each P2P Group when the P2P Group is formed and this shall remain the same for the lifetime of that P2P Group. The format of the P2P Group ID attribute is defined in Section 4.1.17.

The P2P Group ID contains the globally unique P2P Device Address of the P2P Group Owner which assures that different P2P Devices create P2P Groups differentiated from each other. A P2P Group Owner shall determine the Credentials that are required to join a P2P Group. The Credentials shall be fresh for each P2P Group formed. The Credentials for a P2P Group issued to a P2P Device shall:

- Use WPA2-Personal as Authentication Type.
- Use AES as Encryption Type.
- Use a Network Key Type of 64 Hex characters.
- Use a different SSID for each group to assure that all P2P Groups are unique.

A P2P Group Owner shall maintain a WPA2-Personal pass-phrase for delivery to Legacy Clients or to allow a network to be established without WSC. This may be delivered using WSC, or in the case of a Legacy Client that does not support WSC, by means outside the scope of this specification. The PSK is derived from the pass-phrase and SSID. The WPA2-Personal pass-phrase shall contain at least eight ASCII characters randomly selected with a uniform distribution from the following character set: upper case letters, lower case letters and numbers.

Each SSID shall begin with the ASCII characters "DIRECT-". This SSID requirement may enable users of Legacy Clients to differentiate between a P2P Group and an infrastructure network. Following "DIRECT-" the SSID shall contain two ASCII characters "xy", randomly selected with a uniform distribution from the following character set: upper case letters, lower case letters and numbers. This SSID requirement makes the probability low that a Legacy Client encounters two P2P Groups with the same SSID and mistakenly attempt to roam between them. Any byte values allowed for an SSID according to IEEE802.11-2020 [1] may be included after the string "DIRECT-xy" (including none).

3.2.2 Starting and maintaining a P2P Group session

The P2P Group Owner may be determined through the Group Formation Procedure described in Section 3.1.4. The P2P Group Owner may be set by

configuration, for example when connecting to a Legacy Client or when cross connection is provided etc. The P2P Group Owner shall assign a P2P Interface Address that it shall use as its MAC address and BSSID for the duration of the P2P Group session. The P2P Group Owner shall select an Operating Channel, following any procedures required for operation in a certain frequency band in a particular regulatory domain. On that Operating Channel, the P2P Group Owner shall transmit probe responses in response to probe requests, and shall transmit beacons advertising the TSF (for timing synchronization), required operational parameters, supported capabilities, membership, and services available within the P2P Group.

A P2P Group Owner shall respond to Probe Request frames following the rules in IEEE 802.11-2020 [1], with the following modifications:

- The P2P Wildcard SSID shall be treated the same as the Wildcard SSID for the purposes of deciding to transmit a response (i.e. in IEEE 802.11-2020 [1], Clause Section 11.1.4.3.4, change “The SSID in the Probe Request frame is the wildcard SSID” to “The SSID in the probe request is the wildcard SSID, the P2P wildcard SSID”)
- When a P2P Group Owner responds to a Probe Request frame containing the P2P IE it shall include the P2P Group Info attribute in the P2P IE in the Probe Response frame. The P2P IE shall include the P2P Group Info attribute unless there are zero connected P2P Clients. A P2P Group Owner shall not include a P2P IE in the Probe Response frame if the received Probe Request frame does not contain a P2P IE.
- If one or more Requested Device Type attributes are present in the Probe Request frame, a P2P Group Owner shall only respond with a Probe Response frame if it has one or more Primary or Secondary Device Type values identical to any of the Requested Device Type values, or if it has a connected P2P Client with one or more Primary or Secondary Device Type values identical to any of the Requested Device Type values. The P2P Group Owner may filter the P2P Group Information returned in the Probe Response frame to include only devices with matching Primary or Secondary Device Type values.
- If a Device ID attribute is present in the P2P IE in a Probe Request frame, a P2P Group Owner shall only respond with a Probe Response frame if its Device Address, or the Device Address of a connected P2P Client matches that in the Device Address field in the Device ID attribute.

In all Probe Responses that it sends, a P2P Group Owner shall set the SSID to the SSID of the group, and shall set the SA and BSSID to its P2P Interface Address.

For operation outside DMG, a P2P Group Owner shall set the ESS subfield to 1 and the IBSS subfield to 0 in the Capability Information field of Beacon and Probe Response frames that it sends. For operation within DMG, a P2P Group Owner shall set the BSS Type field to 2 (PBSS) in DMG Beacon, Probe Response and (Re)Association Response frames that it sends.

A P2P Device shall indicate that it is a P2P Group Owner by setting the Group Owner field of the P2P Capability attribute to 1 in transmitted Beacon, Announce, and Probe Response frames. A P2P Device operating within DMG that includes the P2P element in DMG Beacon frames shall indicate that it is a P2P Group Owner by setting the Group Owner field of the P2P Capability attribute to 1. The P2P Group Limit field in the P2P Capability attribute shall be set to 0 to indicate that additional P2P connections are supported in this P2P Group, and set to 1 if no further P2P connections are supported. A P2P Group Owner shall be able to support a minimum of one Client.

A P2P Device shall include the WSC IE in all transmitted Beacon, Announce, Probe Request and Response frames. A P2P Device operating within DMG may include the WSC IE in transmitted DMG Beacon frames (see Section 4.3.1). Both the Device Name and Primary Device Type are required attributes in the WSC IE. The Secondary Device Type List is an optional attribute in the WSC IE. The inclusion of the WSC IE in the Probe Response frame sent by a P2P Device allows it to advertise human-readable device-specific information. It should be noted that this information is openly advertised.

A Client acquires the Group Credentials through static configuration or through Wi-Fi Protected Setup[2]. When using Wi-Fi Protected Setup [2], the P2P Group Owner shall serve as the WSC Registrar and the Client shall serve as the WSC Enrollee.

A P2P Group Owner shall conform to the relevant sections of IEEE 802.11-2020 [1] when operating at 5 GHz. A P2P Group Owner that desires to change the Operating Channel during a P2P Group session shall use the Extended Channel Switch Announcement as defined in IEEE 802.11-2020 [1] to inform P2P Clients. Alternatively, the P2P Group Owner may perform the Fast Session Transfer (FST) protocol defined in Section 11.31.3 of IEEE 802.11-2020 [1] with one or more P2P Clients to change the Operating Channel or to move the operation of select streams belonging to a P2P Client to a new band/channel. If the Operating Channel is changed as a result of using the FST protocol, then any P2P Client that does not switch to the new Operating Channel shall be disconnected (see Section 3.2.6.2).

3.2.3 Connecting to a P2P Group

A P2P Device discovers a P2P Group or another P2P Device using the Device Discovery procedure described in 3.1.2.

Prior to connecting to the P2P Group the P2P Device shall assign a P2P Interface Address that it shall use as the MAC address of the P2P Client for the duration of the P2P Group session. When a P2P Device joins an existing P2P Group that it has not stored a credential for, it shall send a Provision Discovery Request frame with a single method set in the Config Methods attribute to indicate the desire to enroll in the network, except when NFC Negotiated or Static Handover is in use.

The Provision Discovery Request frame shall be sent to the P2P Device Address of the P2P Group Owner and on the operating channel of the P2P Group. The P2P Group Owner may use this frame as a trigger that a device wants to enroll (maybe an indication can be shown to the user). A P2P Group Owner shall respond to a received Provision Discovery Request frame with a Provision Discovery Response frame. The Config Methods attribute in the Provision Discovery Response frame may have the same method set as in the received Provision Discovery Request frame to indicate success or shall be null to indicate failure. The P2P Client that sent the Provision Discovery Request frame shall assume that process failed if it does not receive a Provision Discovery Response frame within 100 milliseconds of issuing the Provision Discovery Request frame. A P2P Client may proceed regardless of the status of the Provision Discovery Response status.

The P2P Client acquires the Group Credentials through static configuration or through Wi-Fi Protected Setup [2]. When using Wi-Fi Protected Setup [2], the P2P Group Owner shall serve as the WSC Registrar and the P2P Client shall serve as the WSC Enrollee. In order to connect to a P2P Group, the P2P Client operating, using the Credentials, shall engage in the authentication procedure in Section 11.3.4.2 of IEEE 802.11-2020 [1] and the association procedure in Section 11.3.5.2 of IEEE 802.11-2020 [1] with the P2P Group Owner.

A P2P Client shall not attempt to connect to a P2P Group that has the Group Formation bit in the P2P Group Capability Bitmap of the P2P Capability attribute set to 1 unless it is in Group Formation with that P2P Device, as described in 3.1.4.

When a P2P Client associates with a P2P Group Owner, it provides its Device Name, Primary Device Type, and optionally Secondary Device Type List information to the P2P Group Owner by including the P2P Device Info attribute (see Section 4.1.15) and the P2P Capability attribute (see Section 4.1.4) in the P2P IE in the Association Request frame. This information shall be used by the P2P Group Owner for Group Information Advertisement.

When using PIN based WSC, the selected PIN (from the display of either the P2P Client or P2P Group Owner) is indicated using Device Password ID attribute in the WSC M1/M2 messages as shown in Table 1 (when connecting to a P2P Group, the requestor always becomes P2P Client).

3.2.4 P2P Group Owner services for P2P Client discovery

Group Information Advertisement provides a mechanism to discover a P2P Device that is a P2P Client in an existing P2P Group. A P2P Group Owner shall advertise the device information of the P2P Clients currently connected to the P2P Group by including the P2P Group Info attribute in Probe Response frames according to the rules above. The P2P Group Owner shall include a P2P Client Info Descriptor in the P2P Group Info attribute for each P2P Client that is connected to the P2P Group. Once the P2P Group Owner determines that a P2P Client has left the P2P Group, the P2P Client Info Descriptor for that Client

shall be removed from the P2P Group Info attribute. The P2P Group Owner shall not include a P2P Group Info attribute if it has zero connected P2P Clients.

For operation within DMG, a P2P Device may transmit an Information Request frame to the P2P Group Owner to discover other P2P Clients that are a member of the P2P Group as specified in Section 11.28.1 of IEEE 802.11-2020 [1]. The P2P Group Owner shall transmit an unsolicited Information Response frame following the association or security association of a P2P Device with the P2P Group as described in Section 11.3.7 of IEEE 802.11-2020 [1].

A searching P2P Device may send a Device Discoverability Request frame to a P2P Group Owner to request a P2P Client that supports P2P Client Discoverability to become available for exchange of discovery information, or initiation of Group Formation. On reception of a Device Discoverability Request frame with a P2P Device ID attribute that contains the P2P Device Address of a P2P Client in the P2P Group, a P2P Group Owner shall send a GO Discoverability Request frame to the P2P Client. Delivery of the GO Discoverability Request frame may be delayed due to the P2P Client using Power save mechanisms. A P2P Client should stay constantly available for at least a 100 TU after receiving a GO Discoverability Request frame or until communication with the searching P2P Device completes. On successful delivery of the GO Discoverability Request frame the P2P Group Owner shall send the searching P2P Device a Device Discoverability Response frame indicating success in the status code. If the P2P Group Owner cannot deliver a GO Discoverability Request frame to the target P2P Device it shall send the searching P2P Device a Device Discoverability Response frame with the Status attribute indicating fail in the Status Code, as defined in Table 8.

A P2P Client that connects to a P2P Group Owner indicates support for P2P Client Discovery using the P2P Client Discovery bit in the P2P Capability attribute in the Association Request frame. If the P2P Client supports P2P Client Discovery, the P2P Client shall set the P2P Client Discovery bit to 1, otherwise it shall be set to 0. The P2P Client may indicate changed support for P2P Client Discovery in a subsequent (Re)association Request frame.

A searching P2P Device can determine that a P2P Client does not support P2P Client Discovery since the P2P Group Owner includes the P2P Capability attribute of each P2P Client within the P2P Group Info attribute. Alternatively, when operating within DMG, a searching P2P Device may also make this determination upon reception of an Information Response frame that contains the P2P Capability attribute. The following rules apply where a P2P Client has indicated it does not support P2P Client Discovery:

- A searching P2P Device shall not send a Device Discoverability Request frame to a P2P Group Owner containing the P2P Device ID of that P2P Client
- A searching P2P Device shall not send any frame to the P2P Device that is that P2P Client

- The P2P Group Owner shall not send a GO Discoverability Request frame to that P2P Client

A P2P Device that is a P2P Client within a P2P Group should support P2P Client Discoverability unless device or application restrictions prevent it from doing so. A P2P Device that has ended a session as P2P Group Owner of a Persistent P2P Group that has the Persistent Reconnect bit in the P2P Capability attribute set to 1 shall support P2P Client Discovery when it is a P2P Client in a P2P Group. Such a P2P Device should also select appropriate power save timing to minimize the delay in delivery of a GO Discoverability Request frame, e.g. by being available at each TBTT.

A P2P Group Owner that has one or more connected P2P Clients that have indicated support for P2P Client Discovery should take this into account in setting its own discoverability according to the recommendations in Section 3.3.2.

3.2.5 Persistent Group operation

A P2P Device that successfully obtains Credentials for a Persistent P2P Group shall store the P2P Group ID and Credentials for that P2P Group. This enables the P2P Device that is P2P Group Owner to recreate the P2P Group for additional sessions after initial formation. P2P Clients can also request that the P2P Group be restarted and use the stored Credentials to join. The P2P Group Owner of the Persistent P2P Group may also store a list of P2P Device Addresses of P2P Clients that have joined the Persistent P2P Group.

The P2P Group ID and Credentials for a Persistent P2P Group do not change for each session of that P2P Group, however, the P2P Interface Address (and therefore BSSID) and operating channel of the P2P Group may not be the same for each session. The P2P Interface Address used by P2P Clients within a Persistent P2P Group may also change for each session. The Persistent P2P Group bit in the Group Capability Bitmap field in the P2P Capability attribute shall be set in the Beacon, DMG Beacon (if the P2P IE is present in the frame), Announce, and Probe Response frames transmitted by the P2P Group Owner. The Persistent P2P Group, Intra-BSS Distribution and Persistent Reconnect bits in the Group Capability Bitmap field in the P2P Capability attribute in Beacon, DMG Beacon (if the P2P IE is present in the frame), Announce, and Probe Response frames shall be the same for each session.

The P2P Group Owner of a Persistent P2P Group is determined when the P2P Group is formed and is the same P2P Device in subsequent P2P Group sessions. The P2P Group Owner of a Persistent P2P Group shall operate as a P2P Group Owner as described in Section 3.2. The P2P Group Owner may end a P2P Group session as described in Section 3.2.9.

The P2P Device that ended the P2P Group session may:

- Enter the Listen State, see Section 3.1.2.1.1. The P2P Device may be discovered as described in Section 3.1.2.3.

- Join another P2P Group, in which case it may be discovered as described in Section 3.1.2.2.
- Enter the Find Phase, see Section 3.1.2.1.3.

A P2P Group Owner may advertise that it supports P2P Client reconnection without user intervention for a Persistent P2P Group by setting the Persistent Reconnect bit to 1 in the Group Capabilities Bitmap field that it sends describing the P2P Group capabilities. A P2P Device that advertises this for a Persistent P2P Group may use the Listen State to remain discoverable as described in Section 3.1.2.1. The P2P Device may adopt different availability timing within the Listen State to that generally recommended for discoverability in Section 3.1.2.1. The P2P Device may advertise its Listen State availability timing by including the Extended Listen Timing attribute in Probe Request, Probe Response, GO Negotiation Request and (Re)association Response frames as described in Section 4.1.10. Two parameters define P2P Device timing in Listen State: a period of continuous availability and an interval between the start of successive periods. The period of availability should be at least 10 milliseconds. The interval between availability determines the typical time it shall take to discover the P2P Device and should be chosen to meet the needs of target applications for that P2P Device. A P2P Device may communicate the availability timing that it desires of a Persistent P2P Group Owner by including the Extended Listen Timing attribute in (Re)association Request frames.

Note — Although a P2P Device requesting availability timing should include the Extended Listen Timing attribute in all (Re)association Request frames, the attribute shall only have meaning in the (Re)association Request frame sent when connecting to the P2P Group, i.e. it is ignored when associating as part of Provisioning/WSC.

A P2P Device that is the P2P Group Owner of a Persistent P2P Group shall restart the Persistent P2P Group state on completion of a successful P2P Invitation exchange requesting that the Persistent P2P Group be invoked. A P2P Device may also restart a Persistent P2P Group of which it is P2P Group Owner in response to a request from a higher-layer.

When restarting a Persistent P2P Group in DMG, the Discovery DMG Beacon frames transmitted by a P2P Group Owner should have the CC Present field set to 1 and the A-BFT Responder Address field set to the P2P Device Address of the peer P2P Device of the Persistent P2P Group. This serves to limit the number of P2P Devices that respond in the following A-BFT.

A P2P Device may decide to no longer use a Persistent P2P Group in which case it may delete the Credentials of that P2P Group. A Persistent P2P Group ends when the P2P Group Owner deletes the Credentials.

3.2.6 Communication in a P2P Group

3.2.6.1 General

Communication within a P2P Group established outside DMG shall employ WPA2-Personal security with AES-CCMP as the encryption cipher. Communication within a P2P Group operating within DMG shall employ WPA2-Personal security with AES-GCMP as the encryption cipher. Immediately after a successful association, the P2P Group Owner and the newly connected P2P Client shall execute the 4-way handshake, as specified in Section 12.7.6 of IEEE 802.11-2020 [1] when operating outside DMG and in Section 12.6.13 of IEEE 802.11-2020 [1] when operating within DMG, in which the P2P Group Owner shall act as the authenticator and the P2P Client shall act as the supplicant. The resulting temporal encryption keys shall be installed and used to encrypt unicast and broadcast/multicast frames exchanged between the P2P Group Owner and the Client as described in IEEE 802.11-2020 [1].

Higher-layer data services may use IP. The P2P Group Owner shall act as a DHCP server to provide IP addresses to the connected P2P Clients that use IP. The DHCP Server shall at a minimum support Internet Protocol version 4 (IPv4) and assignment of an IP address, subnet mask and should not include the default gateway unless the P2P Device is providing Cross Connect. If P2Ps [10] is supported, the default gateway shall not be included unless the P2P GO is providing Cross Connect. A P2P Client that uses IP shall be capable of acting as a DHCP Client.

Note — While a P2P Device can select distinct IP subnets for each P2P Group for which it is P2P Group Owner, it is possible that a P2P Device connected to more than one P2P Group may end up with colliding subnets. Use of a random component in the selection of IP subnet may reduce the probability of (but not eliminate) this situation occurring.

Data is exchanged between the P2P Group Owner and each connected Client. In addition, for operation within DMG, the data may be directly exchanged between Clients without the intervention of the P2P Group Owner. Both the Group Owner and the Client may employ power savings techniques, so each shall use the appropriate data delivery mechanisms as described in Section 3.3.

The P2P Group Owner may provide a data distribution service between all connected Clients in the P2P Group. A P2P Group Owner that provides such a service shall set the Intra-BSS Distribution bit to 1 in the Group Capability Bitmap field that it sends describing its own capabilities. For operation within DMG, P2P Clients can communicate directly with each other independent of the setting of the Intra-BSS Distribution field or, if a data distribution service is available, can use the PCP forwarding mechanism using A-MSDUs as described in Section 10.12 of IEEE 802.11-2020 [1] to forward frames to another P2P Client.

A P2P Group Owner may cross connect between a WLAN and a P2P Group using any mechanisms above layer 2. Mechanisms for cross connection are

outside the scope of this specification. A P2P Group Owner that provides cross connection shall set the Cross Connection bit to 1 in the Group Capability Bitmap field that it sends describing its own capabilities. A P2P Group Owner shall not cross connect between the WLAN and P2P Group using layer 2 mechanisms. A P2P Group Owner shall not enable cross connection while associated to a WLAN AP that advertises a P2P Manageability attribute with Cross Connection Permitted set to 0.

A P2P Client shall not cross connect between a WLAN and a P2P Group using mechanisms at any layer.

If a WLAN Infrastructure determines that a P2P Device is a P2P Concurrent Device and is operating with the P2P Infrastructure Managed bit in the Device Capability Bitmap field of the P2P Capability attribute (see Table 12 in Section 4.1.4) set to 0, the AP may deauthenticate or disassociate the STA. The Deauthenticate or Disassociate frame shall include the P2P IE with the Minor Reason Code field set to 2 in the Minor Reason Code attribute (see Section 4.1.3).

Note — It is advisable that a P2P Device deauthenticated or disassociated with this Minor Reason Code not attempt to (re)associate to the WLAN AP either:

- with the P2P Infrastructure Managed bit in the Device Capability Bitmap field of the P2P Capability attribute set to 0 until the P2P Device expects that the WLAN AP permissions could have changed, or
- until P2P Device capability is disabled.

Note — Disabling P2P Device capability includes omitting the P2P IE from all Management frames, leaving all P2P Groups and not responding to Invitation Requests.

3.2.6.2 Communication between multi-band capable P2P Devices

As specified in Section 11.31 of IEEE 802.11-2020 [1], a P2P Device indicates that it is a multi-band capable P2P Device by transmitting a Multi-band element. A pair of multi-band capable P2P Devices shall use the FST protocol to transition an FST session from one band/channel to another band/channel. An FST session comprises of all or a subset of all traffic streams between the pair of multi-band capable P2P Devices.

The FST protocol enables the seamless transition of FST sessions across bands/channels according to application requirements, thus providing means for application continuity without noticeable performance degradation. Multi-band capable P2P Devices can use the FST protocol to improve the network loading across bands/channels, to restrict specific types of traffic to specific bands/channels, to use certain bands/channels for offloading purposes, to deal with rapid changes to the operating channel quality, to name a few.

A multi-band P2P Device shall include a P2P IE in transmitted FST Setup Request and FST Setup Response frames. The P2P attributes included in the P2P IE shall be applicable to the frequency band and channel indicated in the

Multi-band element contained in the same frame carrying the P2P IE and as specified in Section 4.2.12.

Following an FST full session transfer between a pair of multi-band capable P2P Devices, the role each P2P Device assumes in the new band/channel is determined by the STA Role field in the P2P Device's last successfully transmitted Multi-band element to the peer P2P Device. The value selected for the STA Role field shall be limited to "PCP", "AP" or "Non-PCP and Non-AP STA".

A P2P Group whose Group Owner is participating in an FST full session transfer may continue operating in the new band/channel only if the Group Owner maintains its role as PCP or AP after the session transfer. Any P2P Client that has not participated in the session transfer with the P2P Group Owner will be disconnected from the P2P Group after the session transfer. A P2P Group Owner participating in an FST full session transfer may follow the procedure in Section 3.2.8 to disconnect P2P Clients that have not moved to the new band/channel as a result of the session transfer.

Note — FST full session transfer refers to a band/channel switch operation under the FST protocol in which all frames are transmitted in the new band/channel after the FST setup protocol state transitions to the Transition Done state.

Note — Before disconnecting P2P Clients, a P2P Group Owner that is performing a full FST session transfer may transmit an FST Setup Response frame in the old band/channel with the Status Code field set to PERFORMING_FST_NOW and with the RA field set to the broadcast address to notify all P2P Clients of the P2P Group Owner session transfer to a new band/channel, as described in Section 11.31.3.2 of IEEE 802.11-2020 [1].

If a P2P Client is assuming the role of PCP or AP after an FST full session transfer, it should follow the procedure in Section 3.2.7 to disconnect from the P2P Group before the session transfer is complete. If possible, the P2P Client should transmit to the P2P Group Owner a Deauthentication frame if the P2P Group is established outside DMG or a Disassociation frame if the P2P Group is established within DMG, on the old band/channel before the FST setup protocol state transitions to the Transition Done state.

If a P2P Group Owner is assuming a non-PCP and non-AP role after an FST full session transfer, it shall follow the procedure in 3.2.9 to end the P2P Group session before the session transfer is complete; i.e., if an orderly shutdown is possible, it shall transmit on the old band/channel a Deauthentication frame if the P2P Group is established outside DMG or a Disassociation frame if the P2P Group is established within DMG to the broadcast address, or individually to each connected P2P Client, before the FST setup protocol state transitions to the Transition Done state.

3.2.7 Disconnecting from a P2P Group

A P2P Client shall, when possible, indicate intent to disconnect from a P2P Group by using either:

- the deauthentication procedure in Section 11.3.4.4 of IEEE 802.11-2020 [1] to send a Deauthentication frame to the P2P Group Owner if the P2P Group was established outside DMG, or
- the STA disassociation procedure in Section 11.3.5.6 of IEEE 802.11-2020 [1] to send a Disassociation frame to the P2P Group Owner.

A P2P Group Owner shall not depend on receiving either indication and may determine that a Client has departed for a variety of reasons.

3.2.8 Disconnecting a P2P Client

A P2P Group Owner may disconnect a Client from a P2P Group. In order to disconnect a Client, a P2P Group Owner shall use either:

- the deauthentication procedure in Section 11.3.4.4 of IEEE 802.11-2020 [1] to send a Deauthentication frame to the Client if the P2P Group was established outside DMG, or
- the AP disassociation procedure in Section 11.3.5.8 of IEEE 802.11-2020 [1] to send a Disassociation frame to the Client.

If the P2P Group is established outside DMG, the P2P Group Owner shall be the AP in these procedures and the Client shall be the STA. If the P2P Group is established within DMG, the P2P Group Owner shall be the PCP in these procedures and the Client shall be the non-PCP/non-AP STA.

A P2P Group Owner may reject authentication, or deny association of a P2P Device that has previously been deauthenticated, or disassociated due to protocol error, or disruptive behavior.

If authentication is rejected, the status code returned in the Authentication frame with Authentication transaction sequence 2 shall be set to 37 (The request has been declined). See Section 9.4.1.9 and Section 12.3.3.2 of IEEE 802.11-2020 [1].

If association is denied, a P2P Information Element shall be included in the Association Response frame containing a P2P Status attribute with the status code value 6 (Fail: denied due to previous protocol error, or disruptive behavior).

3.2.9 Ending a P2P Group session

If an orderly shutdown is possible, a P2P Group Owner shall indicate to the connected Clients its intention to end a P2P Group session. Unexpected departure of a P2P Group Owner shall terminate the P2P Group session.

For operation outside DMG, a P2P Group Owner indicating intent to terminate a P2P Group session shall use the deauthentication procedure in Section 11.3.4.4 of IEEE 802.11-2020 [1] to send a Deauthentication frame to the broadcast address, or to all connected Clients. The reason code in the



deauthentication frame shall take the value 3 (Deauthenticated because sending STA is leaving (or has left) IBSS, or ESS).

For operation within DMG, a P2P Group Owner indicating intent to terminate a P2P Group session shall use the disassociation procedure in Section 11.3.5.8 of IEEE 802.11-2020 [1] to send a Disassociation frame to the broadcast address, or to all connected Clients. The reason code in the Disassociation frame shall be equal to 8 (Disassociated because sending STA is leaving (or has left) BSS).

If there are no connected P2P Clients the P2P Group Owner may end the P2P Group session.

3.3 P2P Power Management

3.3.1 Introduction

P2P power management supports power save mechanisms for P2P Group Owners and P2P Clients when the P2P Group operates outside DMG. If the P2P Group operates within DMG, the power management procedures specified in Section 11.2.5 of IEEE 802.11-2020 [1] shall be used instead.

Note — While the DMG power management mechanisms in IEEE 802.11-2020 [1] are not identical to the mechanisms in Section 3.3, they provide equivalent functions as follows:

- CTWindow and P2P Group Owner Opportunistic Power Save: A P2P Group Owner operating within DMG may be available to P2P Clients for a known time period at the beginning of each beacon interval, after which the P2P Group Owner can enter a power save mode.
- Notice of Absence (NoA): A P2P Group Owner operating within DMG may schedule PCP Doze BIs to replicate NoA schedules that span one or more beacon intervals. NoA schedules confined to a single beacon interval can be implemented through dynamic or pseudo-static allocations, or through an Awake Window defined within a contention-based access period.
- P2P Client power management and signaling of Client service requirements: Direct Client-to-Client communication when operating within DMG eliminates the need for P2P Group Owner presence to forward the traffic flows from one Client to another; for communication between the P2P Group Owner and a Client, the P2P Group Owner can align its power save schedule with the Client's power save schedule.

The P2P power management approach for operation outside DMG is based on existing PS and WMM-PS power management delivery mechanisms with two new procedures that allow the P2P Group Owner to be absent for defined periods; Opportunistic Power Save and Notice of Absence. Small adaptations to PS and WMM-PS protocols at the P2P Client are necessary to allow for P2P Group Owner absence periods. The adapted protocols are termed P2P PS and P2P WMM-PS to differentiate them from the existing schemes on which they

are based. These mechanisms are available in a P2P Group in which only P2P Devices are associated.

Legacy Clients do not understand the P2P protocol and consider the P2P Group Owner to be an AP. Legacy Clients expect an AP to be available all of the time and any mechanism that alters availability may result in undesirable consequences, e.g. needless consumption of spectrum due to multiple retries, or disassociation by the Legacy Client.

11n-capable P2P Devices may use SM Power Save in communication with other 11n capable P2P Devices, or 11n-capable Legacy Clients. An 11n-capable P2P Device must comply with requested 11n SM Power Save settings when transmitting to another 11n-capable P2P Device, or 11n-capable Legacy Client.

3.3.2 Power Management and discovery

P2P Power Management reduces P2P Device availability and therefore impacts the discoverability of that P2P Device. For this reason, the P2P Power Management protocol defines an availability period, called the CTWindow, to assist in maintaining P2P Device discoverability. The CTWindow is a period during which a P2P Group Owner is present.

The P2P Group Owner is responsible for selecting an appropriate value for CTWindow. The CTWindow shall be an integral number of TU and shall always be less than the beacon interval. For a P2P Group Owner that desires to be discoverable, the CTWindow should be at least 10 TU. A CTWindow shall start at each TBTT and extend for the chosen duration. During this time window the P2P Group Owner shall be in the active state subject to the P2P Group Owner power save state precedence rules in Section 3.3.3.2. A P2P Group Owner shall complete any active frame exchange sequence prior to ending the CTWindow.

Note — The priority of Beacon frame transmission in the power save state precedence rules means that use of passive scanning can be helpful in discovering a P2P Group Owner that is using Power Management.

CTWindow is also used for P2P Group Owner Opportunistic Power Save as described in Section 3.3.3.1. It should be noted that it may take a number of DTIM intervals to successfully communicate new, updated or cancelled CTWindow timing to all P2P Clients in a P2P Group.

3.3.3 Power Management at a P2P Group Owner

PS and WMM-PS power save schemes are based on the assumption that the AP is awake to receive changes in power management state information, and in the case of WMM-PS, trigger frames from the STA.

Power management for the P2P Group Owner consists of delivery mechanisms based on those defined for PS and WMM-PS, together with two methods that

allow the P2P Group Owner to be absent for defined periods. These schemes are termed Opportunistic Power Save and Notice of Absence.

3.3.3.1 P2P Group Owner Opportunistic Power Save procedure

P2P Group Owner Opportunistic Power Save is a power management scheme that allows a P2P Group Owner to gain additional power savings on an opportunistic basis.

Opportunistic Power Save uses the CTWindow described in Section 3.3.2. The P2P Group Owner shall indicate that Opportunistic Power Save is enabled by setting the OppPS bit to 1 in the CTWindow and OppPS Parameters field of the Notice of Absence attribute. The CTWindow field shall be set to a non-zero value if the OppPS bit is set to 1.

At any time after the end of each CTWindow, if all of the connected P2P Clients are determined to be in Doze state by the P2P Group Owner, the P2P Group Owner may enter Doze state from that time until the next TBTT. After a DTIM, the P2P Group Owner shall complete delivery of all queued broadcast/multicast frames prior to entering Doze state, even if the total time taken to send these frames exceeds the CTWindow. Delivery of queued broadcast/multicast frames that is interrupted by a NoA absence period, shall continue after the absence period has ended.

As long as any Client is determined to be in Awake state, the P2P Group Owner shall remain in Awake state subject to any advertised Notice of Absence schedule. A P2P Group Owner shall determine that a P2P Client is in the Awake state if it is in the Active mode or if it is in the Power Save mode and has a WMM Unscheduled Service Period (USP) in progress or an unanswered PS-Poll. Figure 14 illustrates an example of P2P Group Owner Opportunistic Power Save with two connected P2P Clients, both using P2P PS.

This scheme creates opportunities for P2P Group Owner power save at the expense of increased latency in P2P Client transmissions, including transitions from Doze state to Awake state. This increased latency means that there is comparable latency for upstream and downstream traffic when a P2P Group Owner uses this mechanism.

Opportunistic Power Save may be used by the P2P Group Owner when connected P2P Clients are using the P2P PS procedures defined in Section 3.3.4.2, or the P2P WMM-PS procedures defined in Section 3.3.4.3. A P2P Group Owner shall cancel any Opportunistic Power Save if it accepts a P2P Presence Request from a connected P2P Client (see Section 3.3.4.4). The P2P Group Owner shall not use Opportunistic Power Save while it has active P2P Presence Requests from one, or more connected P2P Clients.

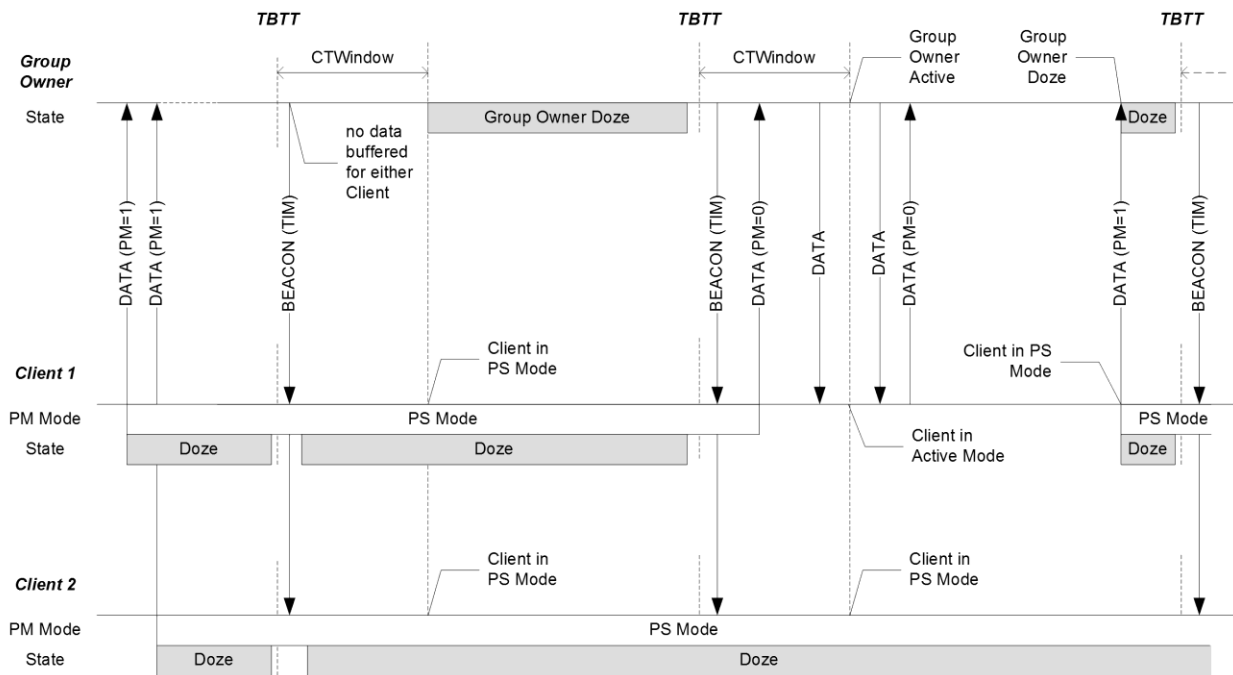

Figure 14—Example of P2P Group Owner Opportunistic Power Save

3.3.3.2 P2P Group Owner Notice of Absence procedure

A P2P Group Owner establishing a Notice of Absence schedule shall include a P2P Notice of Absence attribute describing the planned absence timing within transmitted Beacon and Probe Response frames.

A P2P Group Owner may indicate Notice of Absence timing directly to a P2P Client using a Notice of Absence Action frame.

There shall be no more than one Notice of Absence attribute in a Beacon, Probe Response, or Notice of Absence Action frame.

Notice of Absence timing is specified by the values of the combination of Start Time, Interval, Duration and Count fields in the Notice of Absence attribute — see Table 26. The Start Time field shall indicate the start time of the timing schedule. The Interval field shall indicate the absence interval. The Duration field shall indicate the length of each absence. The Count field shall indicate the number of absences.

The lower order 4 octets of the TSF timer cover a span of around 71 min. Due to TSF timer wrap-over and due to the possibility of receiving a frame containing a Notice of Absence attribute after the indicated Start Time, ambiguity may occur. To resolve this ambiguity:

- The P2P Group Owner shall update the Start Time field in the Notice of Absence attribute for an active schedule every $2^{31}\mu\text{s}$. The Count field in

the Notice of Absence attribute shall also be updated at this time to reflect the number of pending absence periods after the new Start Time.

- To determine Start Time, a P2P Client shall use the nearest absolute TSF timer value in past or future where the lower order 4 octets match the Start Time field in the Notice of Absence attribute.

These measures ensure that new P2P Clients that join during an established Notice of Absence schedule are able to compute absence interval timing.

The Index field within the Notice of Absence information attribute shall contain a number that identifies the instance of Notice of Absence timing. The initial value for the Index field shall be arbitrarily chosen by the P2P Group Owner. The P2P Group Owner shall increment the Index value each time a new Notice of Absence schedule is announced, or whenever any field within the Notice of Absence attribute is changed. A new or revised Notice of Absence schedule shall commence at the time specified in the Start Time field of the Notice of Absence descriptor.

To cancel a Notice of Absence schedule, the P2P Group Owner shall omit the Notice of Absence Descriptor that defines the schedule from the Notice of Absence attribute from the P2P IE in transmitted Beacon and Probe Response frames. If there is neither a Notice of Absence schedule nor a CTWindow after deletion of a Notice of Absence schedule, the Notice of Absence attribute may be omitted from the P2P IE. A Notice of Absence schedule with a Count value indicating a specific number of absences may be cancelled prior to the terminal count. If the Count value is equal to 255, the cycle shall repeat until cancelled.

Note — Cancellation applies immediately that a Beacon frame is transmitted by the P2P Group Owner without a Notice of Absence attribute, even if this occurs during a scheduled absence in a periodic Notice of Absence.

It should be noted that it may take a number of DTIM intervals to successfully communicate new, updated or cancelled Notice of Absence timing to all P2P Clients in the P2P Group. It is recommended that this should be taken into account in setting appropriate Notice of Absence start times, or P2P Group Owner presence during Notice of Absence updates.

The procedure for Notice of Absence at the P2P Group Owner shall be as follows:

1. The first absence period of the announced Notice of Absence timing schedule shall commence when the lower four bytes of the TSF timer at the P2P Group Owner is equal to the Start Time specified in the Notice of Absence attribute.
2. The P2P Group Owner may remain absent for a maximum time equal to the Duration indicated in the Notice of Absence attribute.
3. At the end of the period of absence, the P2P Group Owner shall return to the active state – this is termed a presence period.
4. The next Group Owner absence period shall start when the TSF timer at the P2P Group Owner is equal to Start Time plus one Interval, where

Interval is indicated in the Notice of Absence attribute. Starting at this time, the P2P Group Owner may remain absent for a maximum time equal to the duration indicated in the Notice of Absence attribute.

5. This cycle shall repeat for the number of intervals specified in the Count field of the Notice of Absence attribute. If the Count value is equal to 255, the cycle shall repeat until cancelled.

Figure 15 illustrates an example of Notice of Absence timing at a P2P Group Owner.

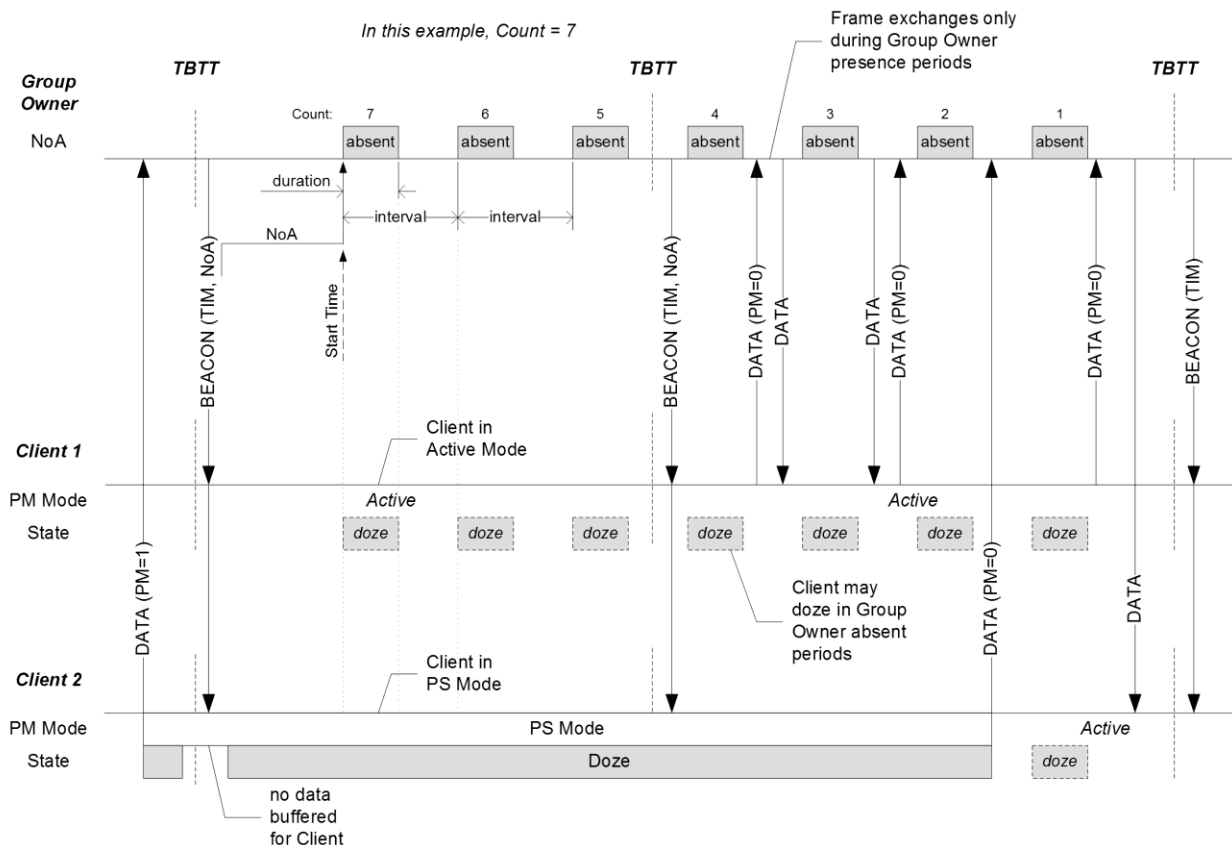

Figure 15—P2P Group Owner Notice of Absence

There shall be a maximum number of two concurrent Notice of Absence timing schedules each described by a Notice of Absence Descriptor in the Notice of Absence Information attribute.

Note — Where Notice of Absence is used in connection with concurrent operation, operational parameters should be chosen, as far as is practical, to balance the needs of both the WLAN and P2P Group. Such operational parameters include Notice of Absence timing and any setting that places requirements on presence on either network, e.g. setting appropriate Max SP Length when using WMM-PS.

P2P Clients may submit a P2P Presence Request to the P2P Group Owner to influence P2P Group Owner power management timing. This mechanism may be used whenever the P2P Client has requirements on the interval between and/or duration of P2P Group Owner presence periods, e.g. where the P2P Client has WMM Traffic Stream (TS), or latency sensitive traffic.

On receipt of a P2P Presence Request, the P2P Group Owner shall determine whether to accept the request. If the P2P Group Owner accepts the P2P Presence Request, it shall respond with a P2P Presence Response action frame containing a Status attribute indicating success and a Notice of Absence attribute describing the Notice of Absence timing that it will use in response to the request. The P2P Group Owner may adopt revised Notice of Absence timing (including becoming continuously available), or continue any Notice of Absence Timing in use when the P2P Presence Request was made. If the P2P Group Owner has no Notice of Absence schedule, it shall respond with a Notice of Absence attribute with no Notice of Absence descriptors. If the P2P Group Owner adopts a new, or modified Notice of Absence schedule as a result of the P2P Presence request, it shall communicate this in all frames that it sends containing the Notice of Absence attribute.

If the P2P Group Owner cannot accommodate a P2P Presence Request, it may deny the request. In this case, the P2P Group Owner shall respond with a P2P Presence Response action frame with a Status attribute indicating the failure status code 'Unable to accommodate request' and a Notice of Absence attribute reflecting any current P2P Group Owner power save timing.

A P2P Group Owner may adjust NoA timing upon disassociation of a P2P Device that made a P2P Presence Request. Successful re-association of that P2P Device has no effect on NoA timing.

The P2P Group Owner may alter NoA timing at any time.

Provided there are no active P2P Presence Requests, Opportunistic Power Save may be combined with a Notice of Absence schedule to allow the P2P Group Owner to gain additional doze time depending on Client PS mode – see Figure 16.

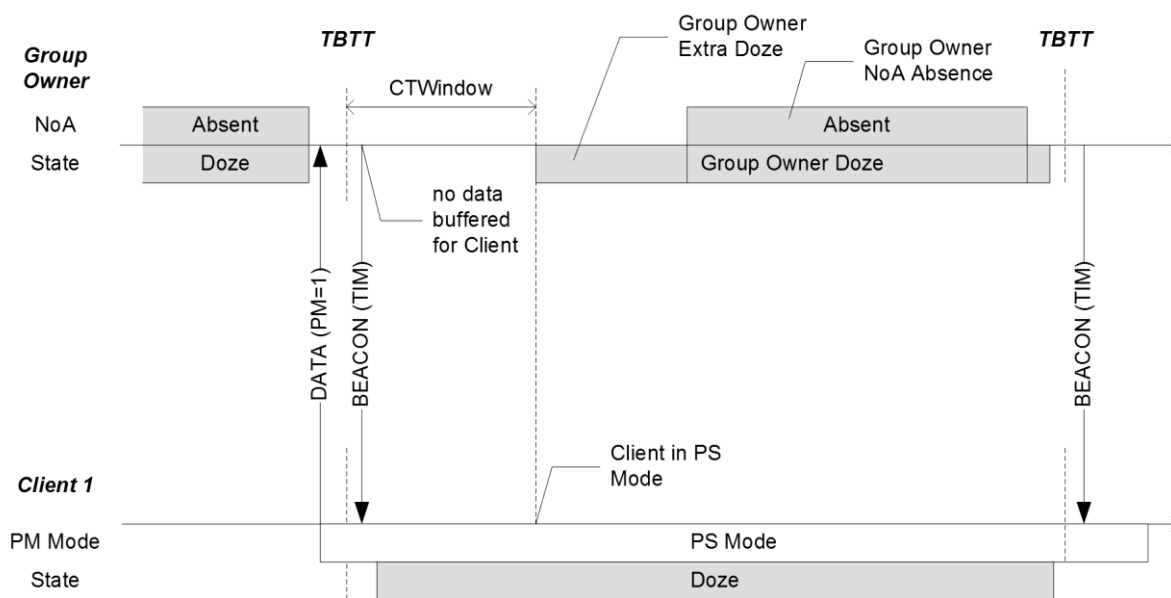

Figure 16—P2P Group Owner Notice of Absence with Opportunistic Power Save

The order of precedence for determining P2P Group Owner power save state shall be as follows:

1. *Highest*: Absence due to a non-periodic Notice of Absence (Count = 1).
2. Presence from TBTT until the end of Beacon frame transmission.
3. Presence during the CTWindow.
4. *Lowest*: Absence for a periodic Notice of Absence (Count > 1).

This means that for any periodic NoA timing schedule (any NoA schedule where the Count value is greater than 1), the P2P Group Owner shall be present for each TBTT to send a Beacon frame independent of that Notice of Absence schedule. It also means that presence during the CTWindow shall take priority over an absence period related to a periodic NoA schedule when both schemes are active.

When two overlapping Notice of Absence schedules are established, periods of absence shall take priority.

When the P2P Group Owner has accepted a Presence Request frame from one or more of its P2P Clients, the use of a non-periodic NoA that extends across multiple presence periods should be minimized and periods of absence should be kept as short as possible to minimize any negative impact.

P2P Group Owner precedence rules are illustrated in Figure 17.

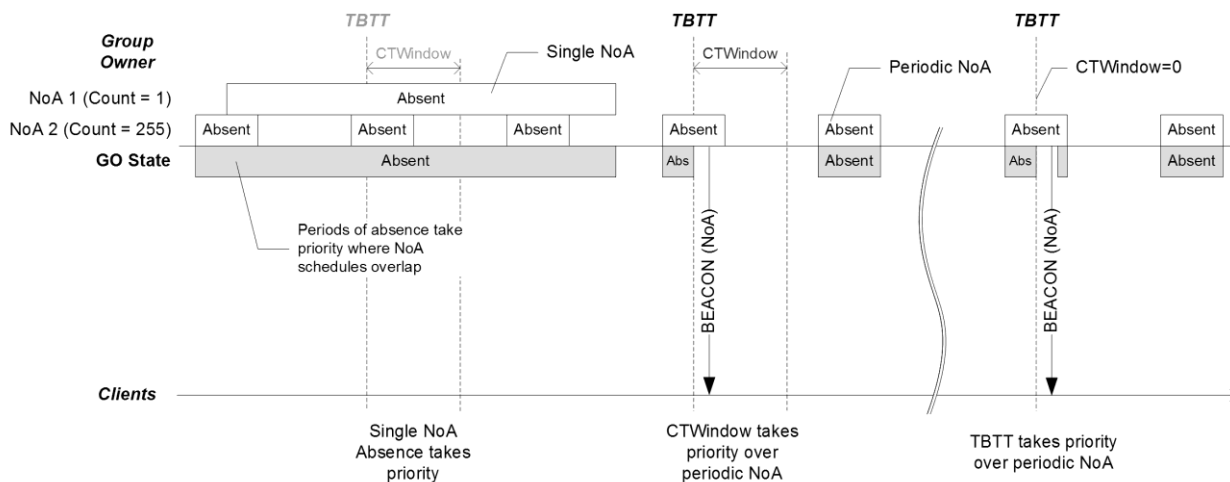

Figure 17—Illustration of P2P Group Owner power save state precedence rules

3.3.3.3 P2P Group Owner Power Save delivery

A P2P Group Owner shall not send frames within the P2P Group during periods that the P2P Group Owner has indicated it will be absent, subject to the power save state precedence rules above. A P2P Device should not initiate a frame exchange sequence that cannot be completed prior to the start of an absence period. Frames transmitted within the frame exchange sequence need not be received or acknowledged by the receiving P2P Device.

The procedures for data delivery from the P2P Group Owner to Clients using PS mode are as specified for an AP in Section 11.2.3.6 of IEEE 802.11-2020 [1].

If the P2P Group Owner receives a PS-Poll frame from a connected P2P Client and is not able to deliver the buffered frame prior to the start of an absence period, it shall defer its transmission until it receives a new PS-Poll from that P2P Client, see Section 3.3.4.2.

The procedures for data delivery from the P2P Group Owner to Clients using WMM-PS power save mode are as specified for an Access Point in Section 3.6.0 and Section 3.6.1 of the WMM-PS Specification [3]. An example of WMM-PS operation with P2P Group Owner NoA is illustrated in Figure 18.

An additional rule governing the end of a WMM Unscheduled Service Period (USP) shall apply if the P2P Group Owner is using Notice of Absence timing. A USP shall end if a P2P Group Owner absence period occurs prior to signaling the end of the USP. When this occurs, the End of Service Period (EOSP) bit in the last frame delivered prior to the absence is 0 and the More bit is 1, indicating that buffered data remains at the P2P Group Owner. It is possible that no frames can be delivered in a USP that is terminated by an absence period. In either case, the P2P Client shall send another trigger in a subsequent P2P Group Owner NoA presence period to retrieve the undelivered data. This

possible shortening of USPs by Group Owner NoA absence periods is illustrated in Figure 19.

3.3.3.4 P2P Group Owner support for Legacy Clients

If a Legacy Client is associated the P2P Group Owner should always be in Active mode, shall not miss more than one consecutive TBTT and shall be present for every TBTT where a DTIM is scheduled. The P2P Group Owner shall support PS and WMM-PS services to associated Legacy Clients.

3.3.4 Power Management at a P2P Client

3.3.4.1 P2P Client operation with P2P Group Owner Power Management

A P2P Client that receives a Notice of Absence descriptor shall assume the specified Notice of Absence timing will commence at the indicated Start Time.

The P2P Client shall not send frames to a P2P Group Owner during periods that the P2P Group Owner has indicated it will be absent, subject to the power save state precedence rules above. P2P Clients shall buffer frames until frame delivery can be attempted in a presence period. A P2P Device should not initiate a frame exchange sequence that cannot be completed prior to the start of an absence period. Frames transmitted within the frame exchange sequence need not be received or acknowledged by the receiving P2P Device.

A P2P Client determines that a P2P Group Owner has Opportunistic Power Save enabled by the OppPS bit being set to 1 in the CTWindow and OppPS Parameters field of received Notice of Absence attributes. In this case, a P2P Client in Power Save mode shall only send frames to a P2P Group Owner during the CTWindow, subject to any non-periodic NoA, and with the exception that the P2P Client shall respond to frames received after the end of the CTWindow in relation to an incomplete WMM Unscheduled Service Period (USP), or outstanding PS-Poll.

A P2P Client that has requirements on the P2P Group Owner presence periods may submit a P2P Presence Request to the P2P Group Owner to influence P2P Group Owner power management timing, see Section 3.3.4.4.

A P2P Client shall use P2P PS, or P2P WMM-PS protocols if it uses power save operation.

3.3.4.2 Procedures for P2P Power Save at a P2P Client

The procedures for the operation of a P2P Client using P2P power save are as specified for a non-AP STA in PS mode in Section 11.2.3.7 of IEEE 802.11-2020 [1].

If a P2P Client using P2P Power Save sends a PS-Poll frame to the P2P Group Owner, the P2P Group Owner may be unable to deliver a buffered frame prior to the start of an absence period. When this occurs, the P2P Client may sleep for the P2P Group Owner absence period and shall send another PS-Poll frame in a subsequent presence period to retrieve the undelivered data.

3.3.4.3 Procedures for P2P WMM-PS at a P2P Client

The procedures for the operation of the P2P Client using P2P WMM-PS are as specified for a non-AP STA using U-APSD in Section 3.6.0 and Section 3.6.2 of the WMM-PS Specification [3]. An example of P2P WMM-PS operation with P2P Group Owner NoA is illustrated in Figure 18.

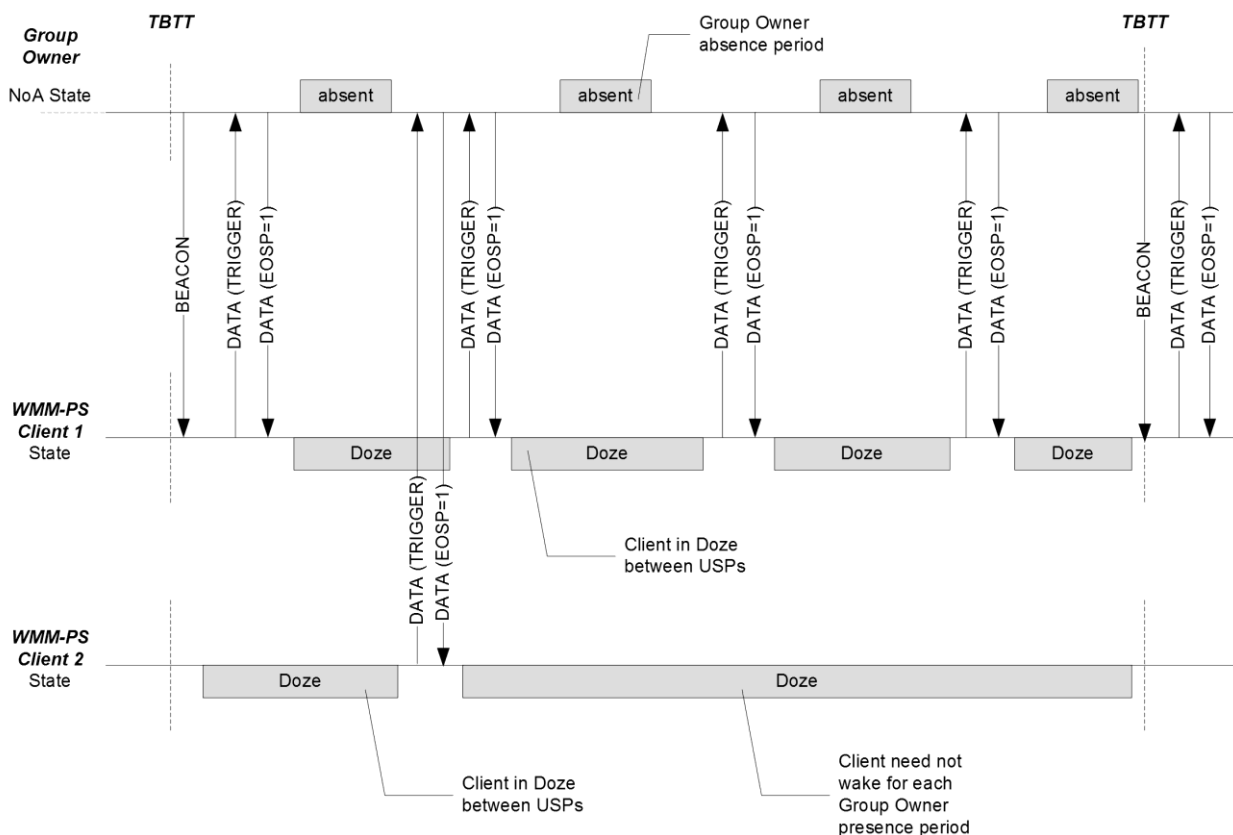

Figure 18—Example P2P WMM-PS operation with P2P Group Owner NoA

An additional rule governing the end of a WMM Unscheduled Service Period (USP) shall apply if the P2P Group Owner is using Notice of Absence timing. A USP shall end early if a P2P Group Owner absence period starts prior to signaling the end of the USP. When this occurs, the End of Service Period (EOSP) bit in the last frame delivered prior to the absence is 0 and the More bit is 1, indicating that buffered data remains at the P2P Group Owner. It is possible that no frames can be delivered in a USP that is terminated by an absence period. In either case, the P2P Client shall send another trigger in a subsequent P2P Group Owner NoA presence period to retrieve the undelivered data. This possible shortening of USPs by Group Owner NoA absence periods is illustrated in Figure 19.

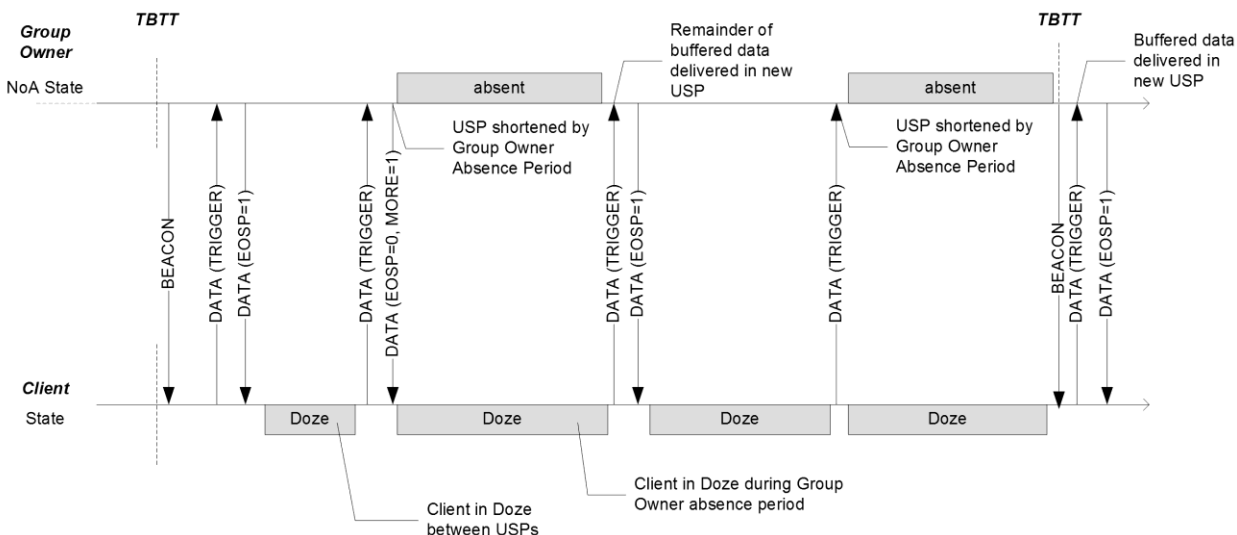

Figure 19—Shortening of P2P WMM-PS USPs by P2P Group Owner absence

3.3.4.4 Signaling of Client service requirements

A P2P Client may submit a P2P Presence Request to the P2P Group Owner to influence P2P Group Owner power management timing. This mechanism may be used whenever the P2P Client has requirements on the P2P Group Owner presence periods. A P2P Presence Request may be made at any time after successful association, regardless of whether the P2P Group Owner is using any power save mechanism at the time.

To make a P2P Presence Request, a P2P Client shall send a P2P Presence Request action frame to the P2P Group Owner. The value for the Dialog Token field shall be chosen by the P2P Client to identify the Request-Response transaction.

The P2P Presence Request action frame shall contain a single P2P NoA attribute. The Index field shall be set to 0 on transmission by the P2P Client and ignored on reception by the P2P Group Owner. The CTWindow field is unused and shall be set to 0 on transmission by the P2P Client and ignored on reception by the P2P Group Owner.

The requested P2P Group Owner presence shall be specified by the Duration and Interval fields in up to two NoA descriptors; one indicating the preferred duration and interval timing and one indicating the maximum interval, and minimum duration acceptable to the P2P Client. The Count/Type field is used to indicate whether the Duration and Interval field values are preferred, or the acceptable limit. The Start Time field is reserved and shall be set to 0 on transmission and ignored on reception in NoA descriptors sent by a P2P Client.

Note — If the P2P Client is making a P2P Presence Request in order to support a WMM Traffic Stream where a TSPEC has been accepted and the P2P Group Owner returned a Medium Time in the ADDTS response, it is recommended

that the requested presence Duration be based on the Medium Time in combination with the requested presence Interval. Where there is no applicable TSPEC, or no Medium Time information has been returned by the P2P Group Owner in an ADDTS response, it is recommended that the P2P Client use the Medium Time derivation in Section A.3 of the WMM Specification [3] to compute a local version of ‘Medium Time’ that can be used together with Interval to determine an appropriate presence Duration.

Figure 20 illustrates the P2P Presence Request-Response procedure.

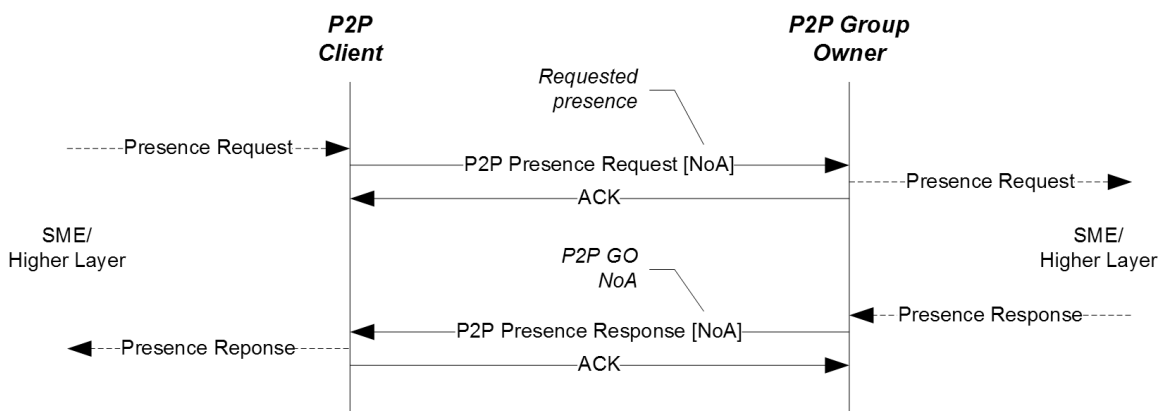

Figure 20—P2P Presence Request-Response procedure

The P2P Client shall adopt the timing indicated in the returned Notice of Absence attribute. If the P2P Group Owner responds with a P2P Presence Response frame containing no Notice of Absence descriptors, the P2P Client shall assume the P2P Group Owner has no Notice of Absence Schedule.

If the Status element in the P2P Presence Response indicates failure, or if the Status element indicates success, but the timing indicated in the returned Notice of Absence attribute does not meet the requirements of the P2P Client, the P2P Client may:

- send a new P2P Presence Request with revised timing,
- use the timing indicated in the returned Notice of Absence attribute, or
- disconnect from the P2P Group.

A P2P Client may submit a request for revised P2P Group Owner presence, by submitting a new P2P Presence Request to the P2P Group Owner.

A P2P Client that no longer has presence requirements should indicate this to the P2P Group Owner by sending a P2P Presence Request Action frame containing no NoA descriptors. A P2P Group Owner may assume that a P2P Client no longer has presence requirements upon determining that the P2P Client has left the P2P Group.

The P2P Group Owner may alter NoA timing at any time and indicate this via the methods described in Section 3.3.3.2. The P2P Client shall adopt the most recently obtained NoA timing.

3.4 Managed P2P Device operations

This section describes the ability for P2P Devices to operate in an enterprise environment where P2P Devices may be managed by the Information Technology (IT) department of the enterprise.

3.4.1 Managed P2P Device capability

P2P Devices may or may not be managed based on the Managed P2P Device capabilities of P2P Devices and WLAN APs.

A WLAN AP that is capable of managing P2P Devices (e.g. Enterprise IT owned and operated AP) shall include the P2P Manageability attribute with the P2P Device Management bit set to 1 in the P2P IE in Beacon, DMG Beacon, Announce, Probe Response and (Re)association Response frames. The WLAN AP advertises its Managed P2P permissions in the Cross Connection Permitted and Coexistence Optional fields in the P2P Manageability attribute (see Section 4.1.12) in the P2P IE in Beacon, DMG Beacon, Announce, Probe Response and (Re)association Response frames. A WLAN AP that is capable of managing P2P Devices but is not a P2P Group Owner shall not include in the P2P IE attributes other than the P2P Manageability attribute. The P2P Device Management bit set to 0 indicates that the WLAN AP (e.g. Enterprise IT department) has no desire to manage P2P Devices.

Note — a WLAN AP that is capable of managing P2P Devices may or may not be a P2P Group Owner

A Managed P2P Device shall include the P2P Capability attribute with the Infrastructure Managed bit set to 1 in the P2P IE in Probe Request and (Re)association Request frames that are transmitted to the WLAN AP by the WLAN STA interface. Both P2P Group Owners and P2P Clients may be Managed P2P Devices. A value of 0 indicates the device may not be managed by the enterprise IT department.

If the P2P Device is a P2P Group Owner, supports Concurrent Operation (has set the Concurrent Operation bit to 1 in the P2P Capability Subfield) and will use cross connection to the WLAN AP BSS, the Cross Connection bit in the Group Capability Bitmap field of the P2P Capability attribute in (Re)association Request frame shall be set to 1 and set to 0 otherwise.

A Managed P2P Device may be a P2P Concurrent Device that has one MAC entity operating as a WLAN-STA and the second MAC entity operating as a P2P Group Owner, as shown in Figure 21.

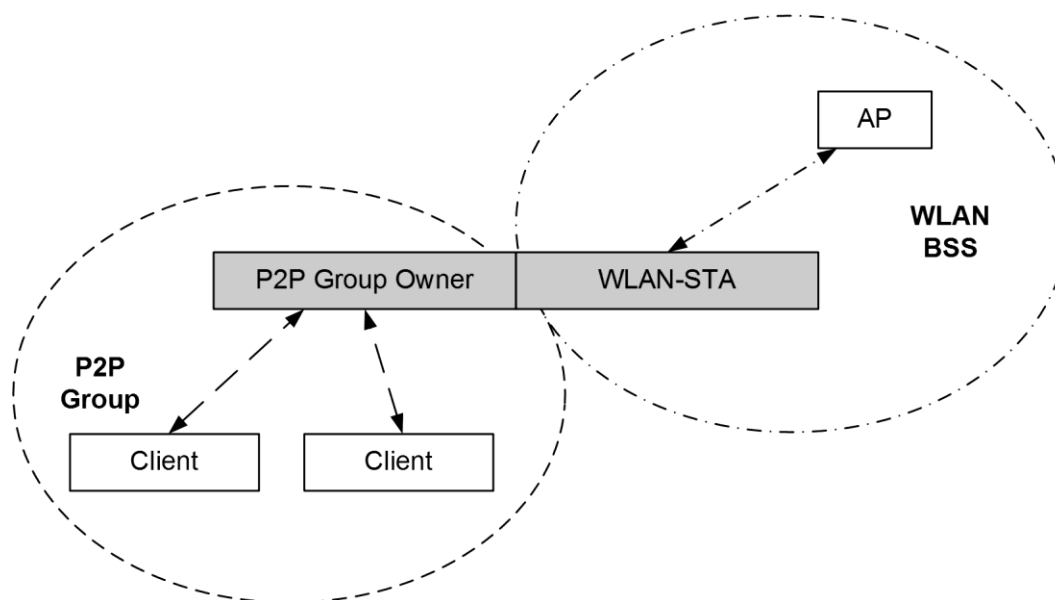

Figure 21—Managed P2P Device that is a P2P Concurrent Device

A Managed P2P Device may also be a P2P Concurrent Device that has one MAC entity operating as a WLAN-STA and the second MAC entity operating as a P2P Client.

If a Managed P2P Device is a P2P Concurrent Device, the WLAN-STA interface of the P2P Device shall include the P2P Interface attribute (see 4.1.18) within a P2P IE in the (Re)association Request frame that is transmitted to the WLAN AP. The Managed P2P Device that is a P2P Concurrent Device shall already have assigned all addresses that may be used as P2P Interface Addresses before the (re)association with the WLAN AP.

Note — In this way, a WLAN AP that is capable of managing P2P Devices is notified of all potential P2P Interface Addresses of the Managed P2P Device that is a P2P Concurrent Device in use during the current association with the WLAN AP. WLAN APs that are incapable of managing P2P Devices may also receive this information but cannot parse it.

3.4.2 P2P Coexistence Parameters operations

The Managed P2P Device may gather P2P Coexistence Parameters by using the Channel Usage Procedures as defined in Section 11.21.15 of IEEE 802.11-2020 [1], or from (Re)association Response frames received on the WLAN-STA interface from the WLAN AP. The WLAN AP that supports Managed P2P Devices shall include P2P Coexistence Parameters in Probe Response and (Re)association Response frames.

The P2P Coexistence Parameters consist of Primary P2P Coexistence Parameters and Secondary P2P Coexistence Parameters.



The Primary P2P Coexistence Parameters contain Channel Usage information that may be used by IT departments to optimize P2P Devices within the IT defined channel mappings assigned to IT controlled APs. The Managed P2P Device that is a P2P Concurrent Device should use Primary P2P Coexistence Parameters as part of channel selection processing to start a P2P Group. If the P2P Group is already started or the Managed P2P Device is not a P2P Concurrent Device, the Primary P2P Coexistence Parameters may be used by the Managed P2P Device to initiate a channel switch or as part of channel selection processing respectively.

The Secondary P2P Coexistence Parameters consist of P2P Client specific parameters such as maximum transmit power (via the Country and Power Constraint elements) and WMM Parameter Element. The Secondary P2P Coexistence Parameters are used to allow Enterprise IT to give WLAN and P2P Devices the same access priority to the medium. The Managed P2P Device that is a P2P Group Owner may use the Secondary P2P Coexistence Parameters as part of determining its maximum transmit power and WMM Parameters Elements for P2P Clients. If the P2P Group Owner is a P2P Concurrent Device in which the P2P Group operates at the same channel with the WLAN BSS, the P2P Group Owner should use the Secondary P2P Coexistence Parameters as part of determining its maximum transmit power and WMM Parameters Elements for P2P Clients. The P2P Group Owner may also set its maximum transmit power and WMM Parameters Elements based on local device decisions that trade off the Enterprise IT benefits and P2P Group benefits. For example, a public printer benefits from longer range more so than a conference room projector; thus, the transmit power may not be the same for the two devices.

The normative behaviors of a P2P Group Owner setting P2P Coexistence Parameters are shown in Table 2.

Table 2—P2P Coexistence Parameters setting

Device Configuration	Primary P2P Coexistence Parameters		Secondary P2P Coexistence Parameters
	New Group	Existing Group	
Managed P2P Device that is a P2P Concurrent Device	Recommended	Optional	Recommended for a P2P Group that operates in the same channel with the WLAN BSS, and optional otherwise
Managed P2P Device that is not a P2P Concurrent Device	Optional	Optional	Optional

In general, application of the P2P Coexistence Parameters to a P2P Group is a device implementation decision. However:

- A P2P Concurrent Device that is a Managed P2P Device shall adopt the Primary P2P Coexistence Parameters and recommended (see Table 2)



Secondary P2P Coexistence Parameters while associated to a WLAN AP that advertises Coexistence Optional set to 0, if the Primary P2P Coexistence Parameters include the WLAN AP's serving channel.

- A P2P Concurrent Device that is a Managed P2P Device should adopt the Primary P2P Coexistence Parameters while associated to a WLAN AP that advertises Coexistence Optional set to 0 if (1) the P2P Device is capable of concurrently operating in a WLAN BSS and a P2P Group that are each operating on different bands and (2) the Primary P2P Coexistence Parameters include a channel on a different band than the WLAN AP's serving channel.

The Enterprise IT department may not allow Concurrent P2P Devices to connect to the WLAN infrastructure if these devices do not adhere to these P2P Coexistence Parameters.

A P2P Client that is a Managed P2P Device does not use the P2P Coexistence Parameters since the Operating Class, Channel and Secondary P2P Coexistence Parameters adopted by a P2P Group are chosen by the P2P Group Owner.

3.4.3 WLAN Deauthentication/Disassociation

If a WLAN Infrastructure determines that a P2P Managed Device is a P2P Concurrent Device operating with cross connection enabled, the AP may deauthenticate or disassociate the WLAN STA. The WLAN infrastructure may determine that cross-connection is enabled by the P2P Device setting the Cross Connection bit in the Group Capability Bitmap field of the P2P Capability attribute (see Section 4.1.4) to 1, or via other means. The Deauthenticate or Disassociate frame shall include the P2P IE with the Minor Reason Code field set to 1 in the Minor Reason Code attribute (see Section 4.1.3). This action may be taken independent of the setting of the P2P Infrastructure Managed bit in the Device Capability Bitmap field of the P2P Capability attribute.

Note — It is advisable that a P2P Device deauthenticated or disassociated with a Minor Reason Code set to 1 not attempt to (re)associate to the WLAN AP:

- while cross connection is enabled at the P2P Device and the WLAN AP sets Cross Connection Permitted to 0 in the P2P Manageability attribute in the P2P IE in transmitted Beacons, DMG Beacons (if the P2P IE is present in the frame), Announce, and Probe Response frames, or
- until P2P Device capability is disabled.

If a WLAN Infrastructure determines that a P2P Concurrent Device is using P2P Coexistence Parameters in any fashion that does not meet IT defined policy, the AP may deauthenticate or disassociate the STA. The Deauthenticate or Disassociate frame shall include the P2P IE with the Minor Reason Code field set to 3 in the Minor Reason Code attribute (see Section 4.1.3).

Note — It is advisable that a P2P Device deauthenticated or disassociated with a Minor Reason Code set to 3 not attempt to (re)associate to the WLAN until:



- the P2P Device has more closely adopted the Primary P2P Coexistence Parameters and Secondary P2P Coexistence Parameters (see Section 3.4.2) while the WLAN AP sets Coexistence Optional to 0 in the P2P Manageability attribute in the P2P IE in transmitted Beacons, DMG Beacons (if the P2P IE is present in the frame), Announce, and Probe Response frames, or
- P2P Device capability is disabled.

If a WLAN Infrastructure receives an Association Request frame from a P2P Concurrent Device that contains a P2P Capability attribute (see Section 4.1.4) with the Infrastructure Managed bit set to 1, the AP may deauthenticate or disassociate the WLAN STA if P2P operation is outside the IT defined policy. The Deauthenticate or Disassociate frame shall include the P2P IE with the Minor Reason Code field set to 4 in the Minor Reason Code attribute (see Section 4.1.3).

Note — It is advisable that a P2P Device deauthenticated or disassociated with a Minor Reason Code set to 4 not attempt to (re)associate to the WLAN AP until:

- the P2P Device expects that the WLAN AP permissions could have changed, or
- P2P Device capability is disabled.

Note — The P2P Device may attempt to re-associate to the WLAN Infrastructure with P2P Device capability disabled. Disabling P2P Device capability includes omitting the P2P IE from all Management frames, leaving all P2P Groups and not responding to Invitation Requests.

3.4.4 Managed P2P Device Summary

Requirements for different P2P Device states are summarized in Table 3.

Table 3—Summary of requirements on Managed P2P Devices

Managed P2P Device	P2P Group Owner or P2P Client	Concurrent P2P Device	Requirements
No	P2P Client	Any	Sets Infrastructure Managed bit to 0. Understands Minor Reason Code set to 2. Alternatively, the P2P Device can disable P2P Device capability before (Re)associating to the WLAN.
No	P2P Group Owner	No	Sets Infrastructure Managed bit to 0. Understands Minor Reason Code set to 2. Alternatively, the P2P Device can disable P2P Device capability before (Re)associating to the WLAN.



Managed P2P Device	P2P Group Owner or P2P Client	Concurrent P2P Device	Requirements
No	P2P Group Owner	Yes	<p>Sets Infrastructure Managed bit to 0.</p> <p>Understands Minor Reason Code set to 1 or 2.</p> <p>Shall not enable cross connection while associated to a WLAN AP that advertises a P2P Manageability attribute with Cross Connection Permitted set to 0.</p> <p>Alternatively, the P2P Device can disable P2P Device capability before (Re)associating to the WLAN.</p>
Yes	P2P Client	No	<p>Sets Infrastructure Managed bit to 1.</p> <p>Sets Cross Connection bit to 0.</p> <p>Understands all values of Minor Reason Code.</p>
Yes	P2P Client	Yes	<p>Sets Infrastructure Managed bit to 1.</p> <p>Sets Cross Connection bit to 0.</p> <p>Includes P2P Interface attribute in (Re)association Request.</p> <p>Understands all values of Minor Reason Code.</p>
Yes	P2P Group Owner	No	<p>Sets Infrastructure Managed bit to 1.</p> <p>Sets Cross Connection bit to 0.</p> <p>Uses Primary P2P Coexistence Parameters and Secondary P2P Coexistence Parameters as per Section 3.4.2.</p> <p>Understands all values of Minor Reason Code.</p>
Yes	P2P Group Owner	Yes	<p>Sets Infrastructure Managed bit to 1.</p> <p>Sets Cross Connection bit to 0 or 1.</p> <p>Includes P2P Interface attribute in (Re)association Request.</p> <p>Shall not enable cross connection while associated to a WLAN AP that advertises a P2P Manageability attribute with Cross Connection Permitted set to 0.</p> <p>Uses Primary P2P Coexistence Parameters and Secondary P2P Coexistence Parameters as per Section 3.4.2.</p> <p>Understands all values of Minor Reason Code.</p>

4 Frame formats

This section describes the information elements (see Section 4.1) and frame formats (see Section 4.2) in support of the capabilities described in clause P2P specific functions and services (see Section 2.4).

P2P protocol communication is based on the use of P2P Information Element (P2P IE), P2P Action frame and P2P Public Action frame formats. These utilize the Vendor Specific Information Element and Vendor Specific Action frame formats in IEEE 802.11-2020 [1], with the Wi-Fi Alliance OUI and an OUI Type indicating P2P. A number of P2P attributes are defined; a single P2P IE carries one or more P2P attributes.

A P2P Device shall be able to properly construct a subset of the frames specified in this clause for transmission and to decode a (potentially different) subset of the frames specified in this clause upon validation following reception. The particular subset of these frames that a P2P Device constructs and decodes is determined by the functions and roles supported by that P2P Device, as specified in Section 4.3.

4.1 P2P Information Element

4.1.1 P2P IE format

The Vendor Specific information element format (as defined in IEEE 802.11-2020 [1]) is used to define the P2P information element (P2P IE) in this specification. The format of the P2P IE is shown in Table 4.

Table 4—P2P IE format

Field	Size (octets)	Value (Hexadecimal)	Description
Element ID	1	0xDD	IEEE 802.11 vendor specific usage.
Length	1	variable	Length of the following fields in the IE in octets. The Length field is a variable, and set to 4 plus the total length of P2P attributes.
OUI	3	50 6F 9A	Wi-Fi Alliance specific OUI.
OUI Type	1	0x09 (to be assigned)	Identifying the type or version of P2P IE. Setting to 0x09 indicates Wi-Fi Alliance P2P v1.0.
P2P Attributes	variable		One or more P2P attributes appear in the P2P IE.

The P2P attributes are defined to have a common general format consisting of a 1 octet P2P Attribute ID field, a 2 octet Length field and variable-length attribute-specific information fields, as shown in Table 5.

Table 5—General format of P2P attribute

Field	Size (octets)	Value (Hexadecimal)	Description
Attribute ID	1	variable	Identifying the type of P2P attribute. The specific value is defined in Table 6.
Length	2	variable	Length of the following fields in the attribute.
Attributes body field	variable		Attribute-specific information fields.

Table 6—P2P Attribute ID definitions

Attribute ID	Notes
0	Status
1	Minor Reason Code
2	P2P Capability
3	P2P Device ID
4	Group Owner Intent
5	Configuration Timeout
6	Listen Channel
7	P2P Group BSSID
8	Extended Listen Timing
9	Intended P2P Interface Address
10	P2P Manageability
11	Channel List
12	Notice of Absence
13	P2P Device Info
14	P2P Group Info
15	P2P Group ID
16	P2P Interface
17	Operating Channel
18	Invitation Flags
19	Out-of-Band Group Owner Negotiation Channel
20	Unused *
21	Service Hash

Attribute ID	Notes
22	Session Information Data Info
23	Connection Capability Info
24	Advertisement_ID Info
25	Advertised Service Info
26	Session ID Info
27	Feature Capability
28	Persistent Group Info
29 – 220	Reserved
221	Vendor specific attribute
222 – 255	Reserved

* Unused means this is not available ever to be used.

A P2P Device that encounters an unknown or reserved Attribute ID value in a P2P IE received without error shall ignore that P2P attribute and parse any remaining fields for additional P2P attributes with recognizable Attribute ID values. A P2P Device that encounters a recognizable but unexpected Attribute ID value in the received P2P IE may ignore that P2P attribute.

More than one P2P IE may be included in a single frame. If multiple P2P IEs are present, the complete P2P attribute data consists of the concatenation of the P2P Attribute fields of the P2P IEs. The P2P Attributes field of each P2P IE may be any length up to the maximum (251 octets). The order of the concatenated P2P attribute data shall be preserved in the ordering of the P2P IEs in the frame. All of the P2P IEs shall fit within a single frame and shall be adjacent in the frame. Where a P2P attribute is not contained entirely within a single P2P IE, the P2P Attribute ID and Length fields for that attribute occur only once at the start. Figure 22 illustrates an example where three P2P attributes are carried in two P2P IEs, with the second attribute spanning the P2P IEs.

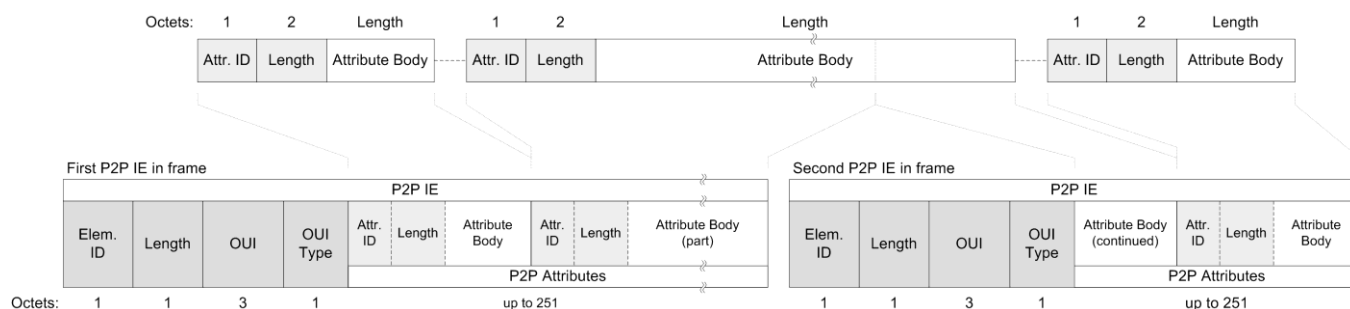

Figure 22—Example of P2P attributes carried in two P2P IEs

In general, the ordering of fields within P2P IEs, attributes and action frames shall follow the conventions in Section 9.2.2 of IEEE 802.11-2020 [1]. An exception shall be that any WSC attributes and data shall be in the big-endian format as defined in the Wi-Fi Protected Setup Specification [2]. WSC IEs shall follow the conventions in the Wi-Fi Protected Setup Specification [2].

Where WSC attribute data appears in both P2P IEs and WSC IEs within the same frame, both occurrences shall contain the same content.

4.1.2 Status attribute

The Status attribute is used to signal status information in the response frame of a request-response transaction. The format of the Status attribute is shown in Table 7.

Table 7—Status attribute format

Field	Size (octets)	Value	Description
Attribute ID	1	0	Identifying the type of P2P attribute. The specific value is defined in Table 6.
Length	2	1	Length of the following fields in the attribute.
Status Code	1	0-255	A status code. The list of valid status codes and their meaning is defined in Table 8.

Table 8 lists the valid value for the Status Code field and corresponding descriptions.

Table 8—Status Code definitions

Status Code	Description
0	Success

Status Code	Description
1	Fail; information is currently unavailable.
2	Fail; incompatible parameters.
3	Fail; limit reached.
4	Fail; invalid parameters.
5	Fail; unable to accommodate request.
6	Fail; previous protocol error, or disruptive behavior.
7	Fail; no common channels.
8	Fail; unknown P2P Group.
9	Fail: both P2P Devices indicated an Intent of 15 in Group Owner Negotiation.
10	Fail; incompatible provisioning method.
11	Fail: rejected by user.
12	Success: Accepted by user
13 – 255	Reserved

The Status attribute shall be included in GO Negotiation Response frames, as described in Section 4.2.9.3, GO Negotiation Confirmation frames, as described in Section 4.2.9.4, P2P Invitation Response frames, as described in Section 4.2.9.6, P2P Presence Response frames, as described in Section 4.2.10.4, and (Re)association Response frames, as described in Section 4.2.5.

4.1.3 Minor Reason Code attribute

The Minor Reason Code attribute is used to augment the 802.11 Reason Code field to signal additional reason information. The format of the Minor Reason Code attribute is shown in Table 9.

Table 9—Minor Reason Code attribute format

Field Name	Size (octets)	Value	Description
Attribute ID	1	1	Identifying the type of P2P attribute. The specific value is defined in Table 6.
Length	2	1	Length of the following fields in the attribute.
Minor Reason Code	1	0-255	A Minor Reason Code. The list of valid Minor Reason Codes and their meaning is defined in Table 10.

Table 10 lists the valid values for the Minor Reason Code field and corresponding descriptions.

Table 10—Minor Reason Code definitions

Minor Reason Code	Description
0	Reserved
1	Disassociated/deauthenticated from the WLAN AP because the Cross Connection capability bit is 1 and this capability within this device is outside the IT defined policy. Note: this may be the returned reason code independent of the value of the P2P Infrastructure Managed capability setting.
2	Disassociated/deauthenticated from the WLAN AP because the P2P Infrastructure Managed bit is 0.
3	Disassociated/deauthenticated from the WLAN because a P2P Concurrent Device is not setting P2P Coexistence Parameters within the IT defined policy; this applies to either primary or secondary P2P Coexistence Parameters.
4	Disassociated/deauthenticated from the WLAN AP because the P2P Device has included the P2P IE with the P2P Infrastructure Managed bit set to 1 and P2P operation within this device is outside the IT defined policy.
5-255	Reserved.

The inclusion of the Minor Reason Code attribute in Deauthentication and Disassociation frames by the WLAN infrastructure is described in Section 3.4.3.

4.1.4 P2P Capability attribute

The P2P Capability attribute contains a set of parameters that can be used to establish a P2P connection. The format of the P2P Capability attribute is shown in Table 11.

Table 11—P2P Capability attribute format

Field	Size (octets)	Value	Description
Attribute ID	1	2	Identifying the type of P2P attribute. The specific value is defined in Table 6.
Length	2	2	Length of the following fields in the attribute.
Device Capability Bitmap	1	variable	A set of parameters indicating P2P Device's capabilities, as defined in Table 12.
Group Capability Bitmap	1	variable	A set of parameters indicating the current state of a P2P Group, as defined in Table 13.

The format of the Device Capability Bitmap field is described in Table 12.

Table 12—Device Capability Bitmap definition

Bit(s)	Information	Notes
0	Service Discovery	The Service Discovery field shall be set to 1 if the P2P Device supports Service Discovery, and is set to 0 otherwise.
1	P2P Client Discoverability	Within a P2P Group Info attribute and a (Re)association request frame the P2P Client Discoverability field shall be set to 1 when the P2P Device supports P2P Client Discoverability, and is set to 0 otherwise. This field shall be reserved and set to 0 in all other frames or uses.
2	Concurrent Operation	The Concurrent Operation field shall be set to 1 when the P2P Device supports Concurrent Operation with WLAN, and is set to 0 otherwise.
3	P2P Infrastructure Managed	The P2P Infrastructure Managed field shall be set to 1 when the P2P interface of the P2P Device is capable of being managed by the WLAN (infrastructure network) based on P2P Coexistence Parameters, and set to 0 otherwise.
4	P2P Device Limit	The P2P Device Limit field shall be set to 1 when the P2P Device is unable to participate in additional P2P Groups, and set to 0 otherwise.
5	P2P Invitation Procedure	The P2P Invitation Procedure field shall be set to 1 if the P2P Device is capable of processing P2P Invitation Procedure signaling, and set to 0 otherwise.
6	Reserved for Miracast in 6 GHz	This bit shall be set to 1 if the P2P Device is capable of establishing a Miracast session in 6 GHz band [11].
7	Reserved	—

The format of the Group Capability Bitmap field is described in Table 13.

Table 13—Group Capability Bitmap definition

Bit(s)	Information	Notes
0	P2P Group Owner	The P2P Group Owner field shall be set to 1 when the P2P Device is operating as a Group Owner, and set to 0 otherwise.
1	Persistent P2P Group	The Persistent P2P Group field shall be set to 1 when the P2P Device is hosting, or intends to host, a P2P Persistent Group, and set to 0 otherwise.
2	P2P Group Limit	The P2P Group Limit field shall be set to 1 when the P2P Group Owner is unable to add additional Clients to its P2P Group, and set to 0 otherwise.

Bit(s)	Information	Notes
3	Intra-BSS Distribution	The Intra-BSS Distribution field shall be set to 1 if the P2P Device is hosting, or intends to host, a P2P Group that provides a data distribution service between Clients in the P2P Group. The Intra-BSS Distribution field shall be set to 0, if the P2P Device is not a P2P Group Owner, or is not providing such a data distribution service. Note — When operating within DMG, the optional data distribution service is provided through the PCP forwarding mechanism using A-MSDUs as described in Section 10.12 of IEEE 802.11-2020 [1].
4	Cross Connection	The Cross Connection field shall be set to 1 if the P2P Device is hosting, or intends to host, a P2P Group that provides cross connection between the P2P Group and a WLAN. The Cross Connection field shall be set to 0 if the P2P Device is not a P2P Group Owner, or is not providing a cross connection service.
5	Persistent Reconnect	The Persistent Reconnect field shall be set to 1 when the P2P Device is hosting, or intends to host, a persistent P2P Group that allows reconnection without user intervention, and set to 0 otherwise.
6	Group Formation	The Group Formation field shall be set to 1 when the P2P Device is operating as a Group Owner in the Provisioning phase of Group Formation, and set to 0 otherwise.
7	IP Address Allocation	The IP Address Allocation field shall be set to 1 if the P2P Device is operating as a Group Owner and supports IP Address Allocation in EAPOL key frames defined in 4.2.8.

The P2P Capability attribute shall be included in Beacon frames, as described in Section 4.2.1, Probe Request frames, as described in Section 4.2.2, Probe Response frames, as described in Section 4.2.3, GO Negotiation Request frames, as described in Section 4.2.9.2, GO Negotiation Response frames, as described in Section 4.2.9.3, GO Negotiation Confirmation frames, as described in Section 4.2.9.4, (Re)association Request frames, as described in Section 4.2.4, Announce frames as described in Section 4.3.1, and Provision Discovery Request frames, as described in Section 4.2.9.9. In addition, the P2P Capability attribute may be included in DMG Beacon frames as described in Section 4.3.1. The Group Capability Bitmap field in the P2P Capability attribute shall be reserved in Probe Request frames, and in Probe Response frames that are transmitted by a P2P Device that is not a Group Owner. The Group Capability Bitmap field in the P2P Capability attribute is used when associating with a WLAN AP that includes P2P IE in Beacon, DMG Beacon (if the P2P IE is present in the frame), Announce, and Probe Response frames; otherwise, it shall be reserved when the P2P Capability attribute is included in the (Re)association Request frames. The use of the P2P Capability attribute is described in Section 3.1.2.

4.1.5 P2P Device ID attribute

The P2P Device ID attribute contains P2P Device Address. The format of the P2P Device ID attribute is shown in Table 14.

Table 14—P2P Device ID attribute format

Field Name	Size (octets)	Value	Description
Attribute ID	1	3	Identifying the type of P2P attribute. The specific value is defined in Table 6.
Length	2	6	Length of the following fields in the attribute.
P2P Device Address	6	—	An identifier used to uniquely reference a P2P Device.

The P2P Device ID attribute shall be present in the P2P IE in the Beacon frame, as described in Section 4.2.1, in the DMG Beacon frame (if the P2P IE is present in the frame), as described in Section 4.3.1, in the Announce frame, as described in Section 4.3.1, and in the Device Discoverability Request frame, as described in Section 4.2.9.7.

4.1.6 Group Owner Intent attribute

The Group Owner Intent attribute contains intent value of a P2P Device's willingness of being the P2P Group Owner. The format of the Group Owner Intent attribute is shown in Table 15.

Table 15—Group Owner Intent attribute format

Field	Size (octets)	Value	Description
Attribute ID	1	4	Identifying the type of P2P attribute. The specific value is defined in Table 6.
Length	2	1	Length of the following fields in the attribute.
GO Intent	1	variable	Information that is used to decide which P2P Device will be the P2P Group Owner. See Table 16.

The Group Owner Intent attribute shall be included in GO Negotiation Request frames, as described in Section 4.2.9.2, and GO Negotiation Response frames, as described in Section 4.2.9.3. The use of the Group Owner Intent attribute is described in Section 3.1.4.

Table 16—GO Intent field definition

Bit(s)	Information	Value	Notes
0	Tie breaker	0 or 1	Indicates which device becomes the GO when the Intent values are the same.
1 – 7	Intent	0 – 15	Relative value between 0 and 15 used to indicate the desire of the P2P Device to be the P2P Group Owner, with a larger value indicating a higher desire.

4.1.7 Configuration Timeout attribute

The Configuration Timeout attribute contains details on the time required by the P2P Device to change from its current mode of operation into P2P Group Owner or P2P Client mode. The format of the Configuration Timeout attribute is shown in Table 17.

Table 17—Configuration Timeout attribute format

Field Name	Size (octets)	Value	Description
Attribute ID	1	5	Identifying the type of P2P attribute. The specific value is defined in Table 6.
Length	2	2	Length of the following fields in the attribute.
GO Configuration Timeout	1	0-255	Time needed by the device to get configured and function as a GO in units of 10 milliseconds.
Client Configuration Timeout	1	0-255	Time needed by the device to get configured and function as a P2P Client in units of 10 milliseconds.

The Configuration Timeout attribute shall be present in the P2P IE in GO Negotiation Request and Response frames, as described in Section 3.1.4. The Configuration Timeout attribute shall be present in P2P Invitation Request and Response frames, as described in Section 3.1.5.

4.1.8 Listen Channel attribute

The Listen Channel attribute contains the Listen Channel and Operating Class information. The format of the Listen Channel attribute is shown in Table 18.

Table 18—Listen Channel attribute format

Field	Size (octets)	Value	Description
Attribute ID	1	6	Identifying the type of P2P attribute. The specific value is defined in Table 6.
Length	2	5	Length of the following fields in the attribute.
Country String	3		The Country String field is set to the value contained in the dot11CountryString attribute in [1], specifying the country code in which the Operating Class and Channel Number fields are valid. The third octet of the Country String field is set to hex 04 to indicate that Table E-4 is used.
Operating Class	1	As defined in [1] Appendix E (non-DMG) and [11] Annex E (DMG)	Indicating the frequency band at which the P2P Device is in the Listen State.
Channel Number	1	As defined in [1] Appendix E (non-DMG) and [11] Annex E (DMG)	Indicating the channel number on which the P2P Device is in the Listen State.

The Listen Channel attribute shall be included in Probe Request frames, as described in Section 4.2.2, and GO Negotiation Request frames, as described in Section 4.2.9.2.

4.1.9 P2P Group BSSID attribute

The P2P Group BSSID attribute contains the BSSID used by a P2P Group Owner for a P2P Group. The format of the P2P Group BSSID attribute is shown in Table 19.

Table 19—P2P Group BSSID attribute format

Field Name	Size (octets)	Value	Description
Attribute ID	1	7	Identifying the type of P2P attribute. The specific value is defined in Table 6.
Length	2	6	Length of the following fields in the attribute.
P2P Group BSSID	6	variable	BSSID used by a P2P Group Owner for a P2P Group.

The P2P Group BSSID attribute shall be included in the P2P Invitation Request frames, as described in Section 4.2.9.5, and P2P Invitation Response frames as described in Section 4.2.9.6.

4.1.10 Extended Listen Timing attribute

The Extended Listen Timing attribute may be used by a P2P Device to communicate the Listen State availability timing it uses in a discoverable state. A P2P Device may also use the Extended Listen Timing Element to suggest a desirable Listen State Timing to a P2P Device that is a P2P Group Owner for a Persistent P2P Group. The format of the Extended Listen Timing attribute is shown in Table 20.

Table 20—Extended Listen Timing attribute format

Field Name	Size (octets)	Value	Description
Attribute ID	1	8	Identifying the type of P2P attribute. The specific value is defined in Table 6.
Length	2	4	Length of the following fields in the attribute.
Availability Period	2	1-65535	The minimum period of continuous availability in Listen State in milliseconds. Availability Period shall be reserved and set to 0 in (Re)association Request frames. See note.
Availability Interval	2	1-65535	The interval between the start of periods of continuous availability in Listen State in units of milliseconds. See note.

Note — A P2P Device using the Extended Listen Timing attribute to communicate that it is continuously available (in Listen State) shall set both Availability Period and Availability Interval to 65535.

The Extended Listen Timing attribute may be present in the P2P IE in Probe Request, Probe Response, GO Negotiation Request and (Re)Association Response frames transmitted by a P2P Device to indicate the Extended Listen Timing of the P2P Device. The Extended Listen Timing attribute may be present in the P2P IE in (Re)association Request frames transmitted by a P2P Device to indicate the Extended Listen Timing desired of a Persistent P2P Group Owner.

4.1.11 Intended P2P Interface Address attribute

The Intended P2P Interface Address attribute contains the P2P Interface Device a P2P Device intends to use in a P2P Group. The format of the Intended P2P Interface Address attribute is shown in Table 21.

Table 21—Intended P2P Interface Address attribute format

Field Name	Size (octets)	Value	Description
Attribute ID	1	9	Identifying the type of P2P attribute. The specific value is defined in Table 6.
Length	2	6	Length of the following fields in the attribute.

Field Name	Size (octets)	Value	Description
P2P Interface Address	6	variable	P2P Interface Address intended to be used in a P2P Group.

The Intended P2P Interface Address attribute shall be present in the P2P IE in GO Negotiation Request and Response frames, as described in Section 3.1.4.

4.1.12 P2P Manageability attribute

The P2P Manageability attribute contains infrastructure manageability information from the WLAN AP to a scanning or associating WLAN STA, which may or may not be a P2P Device. The format of the P2P Manageability attribute is shown in Table 22.

Table 22—P2P Manageability attribute format

Field Name	Size (octets)	Value	Description
Attribute ID	1	10	Identifying the type of P2P attribute. The specific value is defined in Table 6.
Length	2	1	Length of the following fields in the attribute.
Manageability Bitmap field	1	See Table 23	Identifying the WLAN AP's P2P Manageability.

Table 23—Manageability Bitmap field format

Bit	Description
B0	P2P Device Management
B1	Cross Connection Permitted
B2	Coexistence Optional
B3–B7	Reserved

The P2P Device Management field set to 1 indicates that the WLAN AP supports Managed P2P Device. The P2P Device Management field set to 0 indicates that the WLAN has no desire to manage P2P Devices.

The Cross Connection Permitted field set to 1 indicates that the WLAN AP permits P2P Concurrent Devices to offer cross connection. The Cross Connection Permitted field set to 0 indicates that the WLAN AP does not permit P2P Devices that the WLAN AP determines are P2P Concurrent Devices to offer cross connection. See Section 3.4.3.

The Coexistence Optional field set to 1 indicates that the Primary P2P Coexistence Parameters and recommended (see Table 2) Secondary P2P Coexistence Parameters advertised by the WLAN AP are not required. The Coexistence Optional field set to 0 indicates that the Primary P2P Coexistence Parameters and recommended Secondary P2P Coexistence Parameters advertised by the WLAN AP are required for P2P Devices that the WLAN AP determines are P2P Concurrent Devices in order to remain associated to the WLAN. See Section 3.4.3.

The P2P Manageability attribute shall be included in Beacon, Announce, Probe Response, and (Re)association Response frames that are transmitted by the WLAN AP as described in Section 3.4.1. The P2P Manageability attribute may be included in DMG Beacon frames that are transmitted by the WLAN AP as described in 3.4.1.

4.1.13 Channel List attribute

The Channel List attribute contains a list of Operating Class and Channel pair information. The format of the Channel List attribute is shown in Table 24.

Table 24—Channel List attribute format

Field	Size (octets)	Value	Description
Attribute ID	1	11	Identifying the type of P2P attribute. The specific value is defined in Table 6.
Length	2	variable	Length of the following fields in the attribute.
Country String	3		The Country String field is set to the value contained in the dot11CountryString attribute in [1], specifying the country code in which the Channel Entry List is valid. The third octet of the Country String field is set to hex 04 to indicate that Table E-4 is used.
Channel Entry List	variable		Including one or more Channel Entries. The format of Channel Entry field is shown in Table 25.

Table 25—Channel Entry field format

Field	Size (octets)	Value	Description
Operating Class	1	As defined in [1] Appendix E (non-DMG) and [1] Annex E (DMG)	The Operating Class field contains an enumerated value from Appendix E [1] (non-DMG) or Annex E [1] (DMG), specifying the operating class in which the Channel List is valid.
Number of Channels	1		Indicating the number of channels contained in the Channel List field.

Field	Size (octets)	Value	Description
Channel List	variable	As defined in [1] Appendix E (non-DMG) and [1] Annex E (DMG)	The Channel List field contains a variable number of octets, where each octet describes a single channel number. Channel numbering is dependent on Operating Class according to Appendix E [1] (non-DMG) or Annex E [1] (DMG).

The Channel List attribute shall be included in GO Negotiation Request frames, as described in Section 4.2.9.2, GO Negotiation Response frames, as described in Section 4.2.9.3, GO Negotiation Confirmation frames, as described in Section 4.2.9.4, P2P Invitation Request frames, as described in Section 4.2.9.5, and P2P Invitation Response frames, as described in Section 4.2.9.6.

4.1.14 Notice of Absence attribute

The Notice of Absence attribute is used by the P2P Group Owner to signal its absence due to power save timing, concurrent operation, or off-channel scanning. It is also used in the P2P Presence Request-Response mechanism. The format of the Notice of Absence attribute is shown in Table 26.

When operating within DMG, if the Notice of Absence attribute is transmitted it shall be ignored upon receipt.

Table 26—Notice of Absence attribute format

Field Name	Size (octets)	Value	Description
Attribute ID	1	12	Identifying the type of P2P attribute. The specific value is defined in Table 6.
Length	2	$n*(13)+2$	Length of the P2P Notice of Absence attribute body in octets
Index	1	0 – 255	Identifies an instance of Notice of Absence timing.
CTWindow and OppPS Parameters	1	—	Parameters indicating P2P Group Owner's availability window and opportunistic power save capability – see Table 27.
Notice of Absence Descriptor(s)	$n*13$	—	Zero or more Notice of Absence Descriptors each defining a Notice of Absence timing schedule – see Table 28.

The format of the CTWindow and OppPS Parameters field is described in Table 27.

Table 27— CTWindow and OppPS Parameters field format

Bit	Subfield	Notes
7	OppPS	Set to 1 to indicate that the P2P Group Owner is using opportunistic power save. Set to 0 if opportunistic power save is disabled. The CTWindow field shall be non-zero when the OppPS bit is set to 1. Set to 0 in Notice of Absence attributes transmitted by a P2P Client in a P2P Presence Request frame.
0-6	CTWindow	Client Traffic Window (CTWindow). A period of time in TU after a TBTT during which the P2P Group Owner is present. 0 indicates that there shall be no CTWindow. Set to 0 in Notice of Absence attributes transmitted by a P2P Client in a P2P Presence Request frame.

The format of the Notice of Absence Descriptor is shown in Table 28.

Table 28—Notice of Absence Descriptor format

Field Name	Size (octets)	Value	Description
Count/Type	1	1 – 255	Count in Notice of Absence Descriptors sent by a P2P Group Owner; indicates the number of absence intervals. 255 shall mean a continuous schedule; 0 is reserved and shall not be used. Type in Notice of Absence Descriptors sent by a P2P Client in a P2P Presence Request; qualifies the Duration and Interval fields. A Type value of 1 shall indicate preferred values, a Type value of 2 shall indicate acceptable limits.
Duration	4	—	In Notice of Absence Descriptors sent by a P2P Group Owner; indicates the maximum duration in units of microseconds that the P2P Group Owner can remain absent following the start of a Notice of Absence interval. In Notice of Absence Descriptors sent by a P2P Client in a P2P Presence Request; indicates a preferred, or minimum acceptable presence period duration.
Interval	4	—	In Notice of Absence Descriptors sent by a P2P Group Owner; indicates the length of the Notice of Absence interval in units of microseconds. In Notice of Absence Descriptors sent by a P2P Client in a P2P Presence Request; indicates a preferred, or maximum acceptable interval between presence periods.
Start Time	4	—	The start time for the schedule expressed in terms of the lower 4 bytes of the TSF timer. The Start Time field is reserved and shall be set to 0 on transmission and ignored on reception in Notice of Absence attributes transmitted by a P2P Client.

The Notice of Absence attribute shall be present in the P2P IE in the Beacon frames and Probe Response frames transmitted by a P2P Group Owner when a Notice of Absence schedule is being advertised or when the CTWindow is non-zero, as described in Section 4.2.1 and Section 4.2.3. If there is neither a Notice of Absence schedule nor a CTWindow, the GO may omit the Notice of Absence attribute from Beacon and Probe Response frames. The Notice of Absence shall be also present in Notice of Absence frames, as described in Section 4.2.10.2, P2P Presence Request frames, as described in Section 4.2.10.3, and P2P Presence Response frames, as described in Section 4.2.10.4.

4.1.15 P2P Device Info attribute

The P2P Device Info attribute contains information on a P2P Device. The format of the P2P Device Info attribute is shown in Table 29.

Table 29—Device Info attribute format

Field Name	Size (octets)	Value	Description
Attribute ID	1	13	Identifying the type of P2P attribute. The specific value is defined in Table 6.
Length	2	variable	Length of the following fields in the attribute.
P2P Device address	6	—	An identifier used to uniquely reference a P2P Device.
Config Methods	2	As defined in [2]	The WSC Methods that are supported by this device e.g. PIN from a Keypad, pushbutton etc. Contains only the Data part of the WSC Config Methods attribute (see [2]). Note — Byte ordering within the Config Methods field shall be big-endian.
Primary Device Type	8	As defined in Appendix B	Primary Device Type of the P2P Device (see Appendix B). Contains only the Data part of the WSC Primary Device Type attribute (excludes the Attribute ID and Length fields). Note — Byte ordering within the Primary Device Type field shall be big-endian.
Number of Secondary Device Types	1	variable	Indicating number of Secondary Device Types in the Secondary Device Type List field. This field set to 0 indicates no Secondary Device Type List.
Secondary Device Type List	variable	8*n	List of Secondary Device Types of the P2P Client (see [2]). This field is optional. This field is present only if the Number of Secondary Device Types field is not 0 and contains only the Data part of the WSC Secondary Device Type List attribute (excludes the Attribute ID and Length fields). Note — Byte ordering within the Secondary Device Type List field shall be big-endian.
Device Name	variable	As defined in [2]	Friendly name of the P2P Device. Contains the entire WSC Device Name attribute in TLV format (see [2]). Note — Byte ordering within the Device Name field shall be big-endian.

The P2P Device Info attribute shall be included in the (Re)association Request frame as described in Section 4.2.4, the Probe Response frame as described in Section 4.2.3, the GO Negotiation Request frame as described in Section 4.2.9.2, the GO Negotiation Response frame as described in Section 4.2.9.3 and the Provision Discovery Request frame as described in Section 4.2.9.9. In addition, for operation within DMG, the P2P Device Info attribute shall be included in the Probe Request frame during Device Discovery as described in Section 4.2.2.

4.1.16 P2P Group Info attribute

The P2P Group Info attribute contains device information of P2P Clients that are members of the P2P Group. The format of the P2P Group Info attribute is shown in Table 30.

Table 30—P2P Group Info attribute format

Field Name	Size (octets)	Value	Description
Attribute ID	1	14	Identifying the type of P2P attribute. The specific value is defined in Table 6.
Length	2	variable	Length of the following fields in the attribute.
P2P Client Info Descriptor(s)	Sum of all P2P Client Info Descriptor(s)	—	List of P2P Client Info Descriptor(s) for P2P Devices associated with this P2P Group Owner (see Table 31).

The format of the P2P Client Info Descriptor is shown in Table 31.

Table 31—P2P Client Info Descriptor format

Field Name	Size (octets)	Value	Description
Length	1	variable	Length of the following fields.
P2P Device address	6	—	An identifier used to uniquely reference a P2P Device.
P2P Interface address	6	—	An address used to identify a P2P Device within a P2P Group.
Device Capability Bitmap	1	variable	A set of parameters indicating P2P Device's capabilities, as defined in Table 12.

Field Name	Size (octets)	Value	Description
Config Methods	2	As defined in [2]	The WSC Methods that are supported by this device e.g. PIN from a Keypad, pushbutton etc. Contains only the Data part of the WSC Config Methods attribute (see [2]). Note — Byte ordering within the Config Methods field shall be big-endian.
Primary Device Type	8	As defined in Appendix B	Primary Device Type of the P2P Client (see Appendix B). Contains only the Data part of the WSC Primary Device Type attribute (excludes the Attribute ID and Length fields). Note — Byte ordering within the Primary Device Type field shall be big-endian.
Number of Secondary Device Types	1	variable	Indicating number of Secondary Device Types in the Secondary Device Type List field. This field set to 0 indicates no Secondary Device Type List.
Secondary Device Type List	variable	8*n	List of Secondary Device Types of the P2P Client (see [2]). This field is optional. This field is present only if the Number of Secondary Device Types field is not 0 and contains only the Data part of the WSC Secondary Device Type List attribute (excludes the Attribute ID and Length fields). Note — Byte ordering within the Secondary Device Type List field shall be big-endian.
Device Name	variable	As defined in [2]	Friendly name of the P2P Client. Contains the entire WSC Device Name attribute in TLV format (see [2]). Note — Byte ordering within the Device Name field shall be big-endian.

The P2P Group Info attribute shall be included in the Probe Response frame transmitted by a P2P Group Owner unless there are zero connected P2P Clients, as described in Section 4.2.3.

4.1.17 P2P Group ID attribute

The P2P Group ID attribute contains a unique P2P Group identifier of the P2P Group. The format of the P2P Group ID attribute is shown in Table 32.

Table 32—P2P Group ID attribute format

Field Name	Size (octets)	Value	Description
Attribute ID	1	15	Identifying the type of P2P attribute. The specific value is defined in Table 6.
Length	2	6 – 38	Length of the following fields in the attribute.
P2P Device address	6	—	An identifier used to uniquely reference a P2P Device.
SSID	0 – 32	—	SSID field of SSID element as described in Section 8.4.2.2 of [1].

The P2P Group ID attribute shall be included in the P2P Invitation Request frames, as described in Section 4.2.9.5.

4.1.18 P2P Interface attribute

The P2P Interface attribute contains address information of P2P devices. The format of the P2P Interface attribute is shown in Table 33.

Table 33—P2P Interface attribute format

Field Name	Size (octets)	Value	Description
Attribute ID	1	16	Identifying the type of P2P attribute. The specific value is defined in Table 6.
Length	2	variable	Length of the following fields in the attribute.
P2P Device Address	6	—	An identifier used to uniquely reference a P2P Device.
P2P Interface Address Count	1	0-41	Number of P2P Interface Addresses in the P2P Interface Address List field.
P2P Interface Address List	(P2P Interface Address Count) x 6	—	A list of all assigned and non-expired addresses that may be used as P2P Interface Addresses (see Section 2.4.3) by the P2P device within P2P Groups.

The P2P Interface attribute may be present in the P2P IE in the (Re)association Request frame that is transmitted to the WLAN AP by the WLAN-STA interface of the P2P Device, as described in Section 3.4.1.

4.1.19 Operating Channel attribute

The Operating Channel attribute contains Operating Channel and Operating Class information. The format of the Operating Channel attribute is shown in Table 18.

Table 34—Operating Channel attribute format

Field	Size (octets)	Value	Description
Attribute ID	1	17	Identifying the type of P2P attribute. The specific value is defined in Table 6.
Length	2	5	Length of the following fields in the attribute.
Country String	3		The Country String field is set to the value contained in the dot11CountryString attribute in [1], specifying the country code in which the Operating Class and Channel Number fields are valid. The third octet of the Country String field is set to hex 04 to indicate that Table E-4 is used.

Field	Size (octets)	Value	Description
Operating Class	1	As defined in [1] Appendix E (non-DMG) and [1] Annex E (DMG)	Indicating the frequency band at which the P2P Device is operating as the P2P Group Owner, or a preferred operating frequency band.
Channel Number	1	As defined in [1] Appendix E (non-DMG) and [1] Annex E (DMG)	Indicating the channel number on which the P2P Device is operating as the P2P Group Owner, or a preferred operating channel.

The Operating Channel attribute shall be included in Probe Request frames, as described in Section 4.2.2, GO Negotiation Request frames, as described in Section 4.2.9.2, GO Negotiation Response frames, as described in Section 4.2.9.3, GO Negotiation Confirmation frames, as described in Section 4.2.9.4, P2P Invitation Request frames, as described in Section 4.2.9.5, and P2P Invitation Response frames, as described in Section 4.2.9.6.

4.1.20 Invitation Flags attribute

The Invitation Flags attribute contains flags used in the P2P Invitation procedure. The format of the Invitation Flags attribute is shown in Table 11.

Table 35—Invitation Flags attribute format

Field	Size (octets)	Value	Description
Attribute ID	1	18	Identifying the type of P2P attribute. The specific value is defined in Table 6.
Length	2	1	Length of the following fields in the attribute.
Invitation Flags Bitmap	1	variable	A set of flags used in the P2P Invitation procedure, as defined in Table 36.

The format of the Invitation Flags Bitmap field is described in Table 36.

Table 36—Invitation Flags Bitmap definition

Bit	Information	Notes
0	Invitation Type	Differentiates between uses of P2P Invitation Request. Set to 1 to indicate a P2P Invitation Request to re-invoke a Persistent Group, set to 0 to indicate a P2P Invitation Request to join an active P2P Group.
1 – 7	Reserved	—

The Invitation Flags attribute shall be included in P2P Invitation Request frames, as described in Section 4.2.9.5.

4.1.21 Out-of-Band Group Owner Negotiation Channel attribute

The Out-of-Band Group Owner Negotiation Channel attribute contains the Channel and Class information used for the Group Owner Negotiation. The format of the Out-of-Band Group Owner Negotiation Channel attribute is shown in Table 37.

Table 37— Out-of-Band Group Owner Negotiation Channel attribute format

Field	Size (octets)	Value	Description
Attribute ID	1	19	Identifying the type of P2P attribute. The specific value is defined in Table 6.
Length	2	6	Length of the following fields in the attribute.
Country String	3		The Country String field is set to the value contained in the dot11CountryString attribute in [1], specifying the country code in which the Group Formation Class and Channel Number fields are valid. The third octet of the Country String field is set to hex 04 to indicate that Table E-4 is used.
Operating Class	1	As defined in [1] Appendix E	Indicating the preferred Operating Class for the Group Owner Negotiation. Operating Class value shall be set to 0 if no preferred Operating Class is available. If set to 0, the Operating Class information provided in the Channel List attribute shall be used.
Channel Number	1	As defined in [1] Appendix E	Indicating a preferred channel for the Group Formation. Channel Number value shall be set to 0 if no group formation preferred channel is available. If set to 0, P2P Group Owner negotiation with a full channel search based on the information provided in the Channel List attribute shall be used.
Role indication	1		Indicates the current role of the P2P device as defined in Table 38.

Table 38— Role indication field

Value	Notes
0x00	Indicate that the P2P device is not in a group

Value	Notes
0x01	Indicate that the P2P device is a Group Client
0x02	Indicate that the P2P device is a Group Owner
0x03-0xff	Reserved

The Out-of-Band Group Owner Negotiation Channel attribute shall be included in the NFC P2P Handover Select and Handover Request Messages. A P2P device shall use the Role indication field in the Out-of-Band Group Owner Negotiation Channel attribute to indicate its current role. If both P2P devices indicate their current role is Group Owner or if neither device indicates its role is Group Owner, then the Out-of-Band instance used shall be the one from the Handover Select Message.

4.1.22 Service Hash attribute

The Service Hash attribute is used in Probe Requests (as described in Section 4.2.2 (Probe Request frame format)) to search for the existence of a P2P service on peer devices as specified in [10]. The Service Hash attribute contains a 6 octet hash array of the Service Name being searched for. The format of the Service Hash attribute is shown in Table 39 (Service Hash attribute format).

Table 39 – Service Hash attribute format

Field	Size (octets)	Value	Description
Attribute ID	1	21	Identifying the type of P2P attribute. The specific value is defined in Table 66 (P2P Attribute ID definitions)
Length	2	6xN	Length of the following field in the attribute. N represents the number of Service Hash field.
Service Hash(s)	6xN	variable	Contains N Service Hash values. Each Service Hash is 6 octet array of hash of UTF-8 Service Name.

The Service Hash attribute may be included in Probe Request frame, as described in 4.2.2 (Probe Request frame format).

4.1.23 Session Information Data Info

The Session Information Data Info attribute is used in Provision Discovery Request frame (as described in 4.2.9.9 (Provision Discovery Request frame)) and in Provision Discovery Response frame (as described in 4.2.9.10 (Provision Discovery Response frame)) to exchange information specific to the service

prior to establishing connectivity between the peer devices as specified in [10]. The format of the Session Information Data Info attribute is shown in Table 40 (Session Information Data Info attribute format).

Table 40 - Session Information Data Info attribute format

Field	Size (octets)	Value	Description
Attribute ID	1	22	Identifying the type of P2P attribute. The specific value is defined in Table 66 (P2P Attribute ID definitions).
Length	2	variable	Length of the following fields in the attribute. Maximum length is 144 octets.
session_information	variable	variable	Contains service specific information, as defined in [10].

The Session Information Data Info attribute may be included in Provision Discovery Request frame, as described in 4.2.9.9 (Provision Discovery Request frame) and it may be included in Provision Discovery Response frame, as described in 4.2.9.10 (Provision Discovery Response frame).

4.1.24 Connection Capability Info attribute

The Connection Capability Info attribute contains connection capability of a P2P device as specified in [10]. The format of the Connection Capability Info attribute is shown in Table 41 (Connection Capability Info attribute format).

Table 41 - Connection Capability Info attribute format

Field Name	Size (octets)	Value	Description
Attribute ID	1	23	Identifying the type of P2P attribute. The specific value is defined in Table 66 (P2P Attribute ID definitions).
Length	2	1	Length of the following fields in the attribute.
Connection Capability	1	variable	Refer to Section 3.10.3 (ASP-P2P Setup: Connection Capability exchange) of [10] for valid Connection Capability values/bitmask

The Connection Capability Info attribute may be included in Provision Discovery Request frame, as described in 4.2.9.9 (Provision Discovery Request frame), and Provision Discovery Response frames, as described in 4.2.9.10 (Provision Discovery Response frame).

4.1.25 Advertisement ID Info attribute

The Advertisement ID Info attribute uniquely identifies a P2P service advertised by a device as specified in [10]. The Advertisement ID Info attribute is used in the Provision Discovery Request frames to request ASP-Session establishment

to a specific P2P service on a peer device as specified in [10]. The Advertisement ID field is in little endian format. The format of the Advertisement ID Info attribute is shown in Table 42 (Advertisement ID Info Attribute format).

Table 42 - Advertisement ID Info attribute format

Field	Size (octets)	Value	Description
Attribute ID	1	24	Identifying the type of P2P attribute. The specific value is defined in Table 66 (P2P Attribute ID definitions).
Length	2	10	Length of the following field in the attribute.
Advertisement ID	4	0x000000-0xFFFFFFFF	Value of the advertisement ID on remote peer device.
Service MAC Address	6	variable	P2P device address of the Service Advertiser

The Advertisement ID Info attribute may be included in Provision Discovery Request frame, as described in 4.2.9.9 (Provision Discovery Request frame), and Provision Discovery Response frames, as described in 4.2.9.10 (Provision Discovery Response frame).

4.1.26 Advertised Service Info attribute

The Advertised Service Info attribute identifies a particular instance of a P2P service as specified in [10]. The attribute is sent in response to a Probe Request that includes a matching Service Hash attribute. The format of the Advertised Service Info attribute is shown in Table 43 (Advertised Service Info Attribute format) below

Table 43 - Advertised Service Info Attribute format

Field	Size (octets)	Value	Description
Attribute ID	1	25	Identifying the type of P2P attribute. The specific value is defined in Table 66 (P2P Attribute ID definitions).
Length	2	variable	Length of the following fields in the attribute.
Advertised Service Descriptor(s)	Sum of all Advertised Service Descriptor(s)		List of Advertised Service Descriptor(s).

The format of the Advertised Service Descriptor field is shown in Table 44 (Advertised Service Descriptor format) below.

Table 44 - Advertised Service Descriptor format

Field	Size (octets)	Value	Description
Advertisement ID	4	0x00000000-0xFFFFFFFF	Advertisement ID of the local service
Service Config Methods	2	Config Method as defined in [2]	The WSC Methods supported for the corresponding service. Note — Byte ordering within the Service Config Methods field shall be big-endian.
Service Name Length	1	0x00-0xFF	Length of Service Name.
Service Name	variable	variable	UTF-8 string defining the service

The Advertised Service Info attribute may be included in Probe Response frame, as described in Section 4.2.3 (Probe Response frame format).

4.1.27 Session ID Info attribute

The Session ID Info attribute uniquely identifies an ASP-Session. The Session ID Info attribute is used in the Provision Discovery Request frames to request ASP-Session establishment to a specific P2P service on a peer device as specified in [10]. The Session ID field is in little endian. The format of the Session ID Info attribute is shown in Table 45 (Session ID Info Attribute definitions).

Table 45 - Session ID Info Attribute definitions

Field	Size (octets)	Value	Description
Attribute ID	1	26	Identifying the type of P2P attribute. The specific value is defined in Table 66 (P2P Attribute ID definitions)
Length	2	10	Length of the following field in the attribute.
Session ID	4	0x00000000-0xFFFFFFFF	Value of the session_id
Session MAC Address	6	variable	P2P device address of the P2P device which assigned the session_id

The Session ID Info attribute may be included in Provision Discovery Request frame, as described in 4.2.9.9 (Provision Discovery Request frame).

4.1.28 Feature Capability Info attribute

The Feature Capability Info attribute contains feature capabilities of a P2P device as specified in [10]. The format of the Feature Capability Info attribute is shown in Table 46 (Feature Capability Info attribute format).

Table 46 - Feature Capability Info attribute format

Field	Size (octets)	Value	Description
Attribute ID	1	27	Identifying the type of P2P attribute. The specific value is defined in Table 66 (P2P Attribute ID definitions)
Length	2	variable	Length of the following fields in the attribute.
Feature Capability	variable	variable	Refer Section 3.10.5 (ASP-P2P Setup: Feature Capability) of [10] for valid Feature Capability values/bitmask

The Feature Capability attribute may be included in Provision Discovery Request frame, as described in 4.2.9.9 (Provision Discovery Request frame), and Provision Discovery Response frame, as described in 4.2.9.10 (Provision Discovery Response frame).

4.1.29 Persistent Group Info attribute

The Persistent Group Info attribute represents a previously formed P2P Group. The Persistent Group Info attribute is used in the Provision Discovery Request/Response frames to indicate that the peer device has a persistent group available to use. The format of the Persistent Group Info attribute is shown in Table 47 (Persistent Group Info Attribute format).

Table 47 - Persistent Group Info Attribute format

Field	Size (octets)	Value	Description
Attribute ID	1	27	Identifying the type of P2P attribute. The specific value is defined in Table 66 (P2P Attribute ID definitions)
Length	2	variable	Total Length of the MAC address plus SSID
P2P device address	6	variable	P2P device address of the group owner of the Persistent Group.
SSID	0-32	variable	SSID of the Persistent Group

The Persistent Group Info attribute may be included in Provision Discovery Request frame, as described in 4.2.9.9 (Provision Discovery Request frame), and Provision Discovery Response frame, as described in 4.2.9.10 (Provision Discovery Response frame).

4.2 Management Frames

This section defines extensions to 802.11 management frames in support of P2P capabilities.

4.2.1 Beacon frame format

One or more P2P IEs and the WSC IE shall be inserted after other information elements in the Beacon frames transmitted by a P2P Group Owner. P2P attributes for a P2P IE that is included in the Beacon frame are shown in Table 48.

Table 48—P2P attributes in the Beacon frame

Attributes	Attribute ID	Note
P2P Capability	2	The P2P Capability attribute shall be present in the P2P IE.
P2P Device ID	3	The P2P Device ID attribute shall be present in the P2P IE.
Notice of Absence	12	The Notice of Absence attribute shall be present in the P2P IE in the Beacon frames transmitted by a P2P Group Owner when a Notice of Absence schedule is being advertised (see Section 3.3.3.2), or when the CTWindow is non-zero (see Section 3.3.2).



4.2.2 Probe Request frame format

The Probe Request frames can be transmitted by any P2P Device.

One or more P2P IEs and the WSC IE shall be inserted after other information elements in the Probe Request frames transmitted by a P2P Device as shown in Table 49.

Table 49—Probe Request frame format

Order	Information Element	Note
	WSC IE	The WSC IE shall be present in the frames transmitted by a P2P Device.
Last	P2P IE	The P2P IE shall be present in the frames transmitted by a P2P Device.

Additional attributes shall be inserted in the WSC IE that is included in the Probe Request frame as shown in Table 50.

Table 50—Additional attributes in WSC IE in the Probe Request frame

Attributes	Required/Optional	Note
Device Name	Required	The Device Name attribute shall be present in WSC IE in the Probe Request frame that is transmitted by a P2P Device.
Requested Device Type	Optional	The Requested Device Type attribute may be present in WSC IE in the Probe Request frame that is transmitted by a P2P Device.

P2P attributes for a P2P IE that is included in the Probe Request frame are shown in Table 51.

Table 51—P2P attributes in the Probe Request frame

Attributes	Attribute ID	Note
P2P Capability	2	The P2P Capability attribute shall be present in the P2P IE.
P2P Device ID	3	The P2P Device ID attribute may be present in the Probe Request frame when using the discovery protocol to find a P2P Device with a specific Device Address.

Attributes	Attribute ID	Note
Listen Channel	6	The Listen Channel attribute shall be present in the P2P IE indicating the operating class and channel number on which the P2P Device is in the Listen State. If the P2P Device has not selected a Listen Channel, the Listen Channel attribute shall be omitted.
Extended Listen Timing	8	The Extended Listen Timing attribute may be present in the P2P IE to advertise Listen State availability of the P2P Device sending the Probe Request.
P2P Device Info	13	For operation within DMG, the P2P Device Info attribute shall be present in the P2P IE to indicate the P2P Device information.
Operating Channel	17	The Operating Channel attribute shall only be present in the P2P IE if the P2P Device is an operating P2P Group Owner and indicates the operating class and channel number on which the P2P Device is operating as P2P Group Owner.
Service Hash	21	The Service Hash attribute may be present in the P2P IE if P2Ps is supported. The usage of this attribute is defined in the Wi-Fi Peer-to-Peer Services specification [10].

4.2.3 Probe Response frame format

The Probe Response frames can be transmitted by a P2P Device either in its Operating Channel or Listen Channel.

One or more P2P IEs and the WSC IE shall be inserted after other information elements in Probe Response frames transmitted by a P2P Device. P2P attributes for a P2P IE that is included in the Probe Response frame are shown in Table 52.

Table 52—P2P attributes in the Probe Response frame

Attributes	Attribute ID	Note
P2P Capability	2	The P2P Capability attribute shall be present in the P2P IE.
Extended Listen Timing	8	The Extended Listen Timing attribute may be present in the P2P IE.
Notice of Absence	12	The Notice of Absence attribute shall only be present in the P2P IE in the Probe Response frames transmitted by a P2P Group Owner when a Notice of Absence schedule (see Section 3.3.3.2) or non-zero CTWindow (see Section 3.3.2) is being advertised in the Beacon frames (see Section 3.3.3.2).
P2P Device Info	13	The P2P Device Info attribute shall be present in the P2P IE to indicate the P2P Device information.

Attributes	Attribute ID	Note
P2P Group Info	14	The P2P Group Info attribute shall only be present in the P2P IE in the Probe Response frame that is transmitted by a P2P Group Owner. The P2P Group Info attribute shall be omitted if there are zero connected P2P Clients.
Advertised Service Info	25	The Service Instance attribute may be present in the P2P IE if P2Ps is supported. The usage of this attribute is defined in the Wi-Fi Peer-to-Peer Services specification [10].

4.2.4 Association/Reassociation Request frame format

One or more P2P IEs shall be inserted after other information elements in the Association Request or Reassociation Request frame transmitted by a P2P Device.

P2P attributes for a P2P IE that is included in the Association Request or Reassociation Request frame Response frames sent to a P2P Device are shown in Table 53.

Table 53—P2P attributes in the Association/Reassociation Request frame

Attributes	Attribute ID	Note
P2P Capability	2	The P2P Capability attribute shall be present in the P2P IE.
Extended Listen Timing	8	The Extended Listen Timing attribute may be present in the P2P IE in Association Request or Reassociation Request frames transmitted by a P2P Client.
P2P Device Info	13	The P2P Device Info attribute shall be present in the P2P IE.

P2P attributes for a P2P IE that is included in the Association Request or Reassociation Request frame Response frames sent to a WLAN AP by the WLAN-STA interface of a Managed P2P Device are shown in Table 54.

Table 54—P2P attributes in the Association/Reassociation Request frame sent to a WLAN AP by a Managed P2P Device

Attributes	Attribute ID	Note
P2P Capability	2	The P2P Capability attribute shall be present in the P2P IE.
P2P Interface	16	The P2P Interface attribute shall be present in the P2P IE if the Managed P2P Device is a P2P Concurrent Device.

4.2.5 Association/Reassociation Response frame format

One or more P2P IEs shall be inserted after other information elements in the Association Response or Reassociation Response frame transmitted by a P2P Device. P2P attributes for a P2P IE that is included in the Association Response or Reassociation Response frames are shown in Table 55.

Table 55—P2P attributes in the Association/Reassociation Response frame

Attributes	Attribute ID	Note
Status	0	The Status attribute shall be present in the P2P IE to provide status information when a (Re) association Request frame is denied.
Extended Listen Timing	8	The Extended Listen Timing attribute may be present in the P2P IE in Association Response or Reassociation Response frames transmitted by a P2P Group Owner.

Note — At least one P2P IE is always included in the Association/Reassociation Response frame. If neither P2P attribute is required according to the conditions in Table 55, then a P2P IE containing no P2P attributes is included.

4.2.6 Deauthentication frame format

For operation outside DMG, a P2P IE containing the P2P attributes in Table 56 may be included in a Deauthentication frame transmitted by a WLAN AP that is capable of managing P2P Devices.

Table 56—P2P attributes in the Deauthentication frame

Attributes	Attribute ID	Note
Minor Reason Code	1	The Minor Reason Code attribute shall be present in the P2P IE.

4.2.7 Disassociation frame format

A P2P IE containing the P2P attributes in Table 57 may be included in a Disassociation frame transmitted by a WLAN AP that is capable of managing P2P Devices.

Table 57—P2P attributes in the Disassociation frame

Attributes	Attribute ID	Note
Minor Reason Code	1	The Minor Reason Code attribute shall be present in the P2P IE.

4.2.8 IP Address Allocation in EAPOL-Key Frames (4-Way Handshake)

An IPv4 address may be allocated to a P2P Client in a secure manner by using vendor specific KDEs (Wi-Fi Alliance OUI: 50 6F 9A) in EAPOL-Key frames 2 and 3 during the 4-way EAPOL-Key Handshake.

If a P2P Client supports IP address allocation via EAPOL-Key frames, and the Group Owner to which it is associating advertises support for IP Address Allocation in its Group Capability Bitmap field, the P2P Client may request an IPv4 address allocation from the P2P Group Owner by adding an IP Address Request KDE to EAPOL-Key frame 2. If not advertised by the GO, the P2P Client shall not send the request.

If a P2P Group Owner supports IP address allocation via EAPOL-Key frames it shall set the IP Address Allocation field in its Group Capability Bitmap field to 1 and, on receipt of an IP Address Request KDE in a successful EAPOL-Key frame 2, provide an IP address to the P2P Client through the IP Allocation KDE in EAPOL-Key frame 3.

The structure of the IP address Request KDE (Data Type:4) and IP Allocation KDE (Data Type: 5) are shown in Table 58 and Table 59.

Table 58—IP Address Request KDE in the EAPOL-Key frame 2

	Request IP Address
Size (octet)	1

- The Request IP Address shall be set to 1 to indicate an IP address allocation request to the P2P Group Owner.
- A supplicant should not encrypt the IP Address Request KDE in EAPOL-Key msg 2/4.

Table 59—IP Allocation KDE in the EAPOL-Key frame 3

	Client IP Address	Subnet Mask	Group Owner IP Address
Size (octet)	4	4	4

- The Client IP Address shall be set to the address allocated by the P2P Group Owner. The allocated IP address shall be valid throughout the duration of the association between the P2P Group Owner and P2P Client.
- The Subnet Mask shall be set to provide the value of the subnet that the P2P Group Owner is using.
- The Group Owner IP Address shall be set to the address of the P2P Group Owner.

Refer to IEEE802.11-2020 [1] Section 11.6.2 for further details on EAPOL Key frames and Figure 11-30 for the KDE format.

4.2.9 P2P public action frames

4.2.9.1 General format

The Public Action frame format (as defined in IEEE 802.11-2020 [1]) is used to define the P2P public action frames in this specification. The general format of the P2P public action frames is shown in Table 60.

Table 60—General format of P2P public action frame

Field	Size (octets)	Value (Hexadecimal)	Description
Category	1	0x04	IEEE 802.11 public action usage.
Action field	1	0x09	IEEE 802.11 vendor specific usage.
OUI	3	50 6F 9A	Wi-Fi Alliance specific OUI.
OUI type	1	0x09 (to be assigned)	Identifying the type or version of action frame. Setting to 09 indicates Wi-Fi Alliance P2P v1.0.
OUI Subtype	1		Identifying the type of P2P public action frame. The specific value is defined in Table 61.
Dialog Token	1		Set to a nonzero value to identify the request/response transaction.
Elements	variable		Including P2P IE or any information elements defined in IEEE 802.11-2020 [1].

Table 61—P2P public action frame type

Type	Notes
0	GO Negotiation Request
1	GO Negotiation Response
2	GO Negotiation Confirmation
3	P2P Invitation Request
4	P2P Invitation Response
5	Device Discoverability Request
6	Device Discoverability Response
7	Provision Discovery Request
8	Provision Discovery Response
9 – 255	Reserved



4.2.9.2 GO Negotiation Request frame

The GO Negotiation Request frame uses the P2P public action frame format and is transmitted by a P2P Device to another P2P Device to initiate a P2P connection.

The Dialog Token field is set to a nonzero value chosen by the P2P Device sending the GO Negotiation Request frame to identify the request/response /confirm transaction.

The Elements field in the GO Negotiation Request frame contains a P2P IE and WSC IE. P2P attributes for a P2P IE that is included in the GO Negotiation Request frame are shown in Table 62.

Table 62—P2P attributes in the GO Negotiation Request frame

Attributes	Attribute ID	Note
P2P Capability	2	The P2P Capability attribute shall be present in the P2P IE.
Group Owner Intent	4	The Group Owner Intent attribute shall be present in the P2P IE.
Configuration Timeout	5	The Configuration Timeout attribute shall be present in the P2P IE.
Listen Channel	6	The Listen Channel attribute shall be present in the P2P IE.
Extended Listen Timing	8	The Extended Listen Timing attribute may be present in the P2P IE to advertise Listen State availability of the P2P Device sending the GO Negotiation Request,
Intended P2P Interface Address	9	The Intended P2P Interface Address attribute shall be present in the P2P IE.
Channel List	11	The Channel List attribute shall be present in the P2P IE.
P2P Device Info	13	The P2P Device Information attribute shall be present in the P2P IE.
Operating Channel	17	The Operating Channel attribute shall be present in the P2P IE.

The WSC IE that is included in the GO Negotiation Request frame contains the Device Password ID and other attributes as shown in Table 63. The value of Device Password ID attribute shall be set to the specific configuration method that the P2P Device is currently using.

Table 63—WSC IE in the GO Negotiation Request frame

Attribute	R/O	Allowed Values
Version	R	0x10 = version1.0, 0x11 = version 1.1, etc.

Attribute	R/O	Allowed Values
Device Password ID	R	The value of Device Password ID attribute shall be set to the specific configuration method that the P2P Device is currently using. See Section 12 (Data Element Definitions) of the Wi-Fi Protected Setup Specification [2].
<other...>	O	Multiple attributes are permitted.

4.2.9.3 GO Negotiation Response frame

The GO Negotiation Response frame uses the P2P public action frame format and is transmitted by a P2P Device in response of a GO Negotiation frame.

The Dialog Token field is set to a nonzero value received in the GO Negotiation Request frame to identify the request/response/confirm transaction.

The Elements field in the GO Negotiation Response frame contains a P2P IE and WSC IE. P2P attributes for a P2P IE that is present in the GO Negotiation Response frame are shown in Table 64.

Table 64—P2P attributes in the GO Negotiation Response frame

Attributes	Attribute ID	Note
Status	0	The Status attribute shall be present in the P2P IE.
P2P Capability	2	The P2P Capability attribute shall be present in the P2P IE.
Group Owner Intent	4	The Group Owner Intent attribute shall be present in the P2P IE.
Configuration Timeout	5	The Configuration Timeout attribute shall be present in the P2P IE.
Operating Channel	17	The Operating Channel attribute may be present in the P2P IE.
Intended P2P Interface Address	9	The Intended P2P Interface Address attribute shall be present in the P2P IE.
Channel List	11	The Channel List attribute shall be present in the P2P IE.
P2P Device Info	13	The P2P Device Information attribute shall be present in the P2P IE.
P2P Group ID	15	The P2P Group ID attribute shall be present if the P2P Device sending the GO Negotiation Response frame will become P2P Group Owner following Group Owner Negotiation.

The WSC IE that is included in the GO Negotiation Response frame contains the Device Password ID and other attributes as shown in Table 65. The value of

Device Password ID attribute shall be set to the specific configuration method that the P2P Device is currently using.

Table 65—WSC IE in the GO Negotiation Response frame

Attribute	R/O	Allowed Values
Version	R	0x10 = version1.0, 0x11 = version 1.1, etc.
Device Password ID	R	The value of Device Password ID attribute shall be set to the specific configuration method that the P2P Device is currently using. See Section 12 (Data Element Definitions) of the Wi-Fi Protected Setup Specification [2].
<other...>	O	Multiple attributes are permitted.

4.2.9.4 GO Negotiation Confirmation frame

The GO Negotiation Confirmation frame uses the P2P public action frame format and is transmitted by a P2P Device transmitting the Group Owner Request frame to confirm the negotiation completeness.

The Dialog Token field is set to a nonzero value received in the GO Negotiation Response frame to identify the request/response/confirm transaction.

The Elements field in the GO Negotiation Confirmation frame contains a P2P IE. P2P attributes for a P2P IE that is included in the GO Negotiation Confirmation frame are shown in Table 66.

Table 66—P2P attributes in the GO Negotiation Confirmation frame

Attributes	Attribute ID	Note
Status	0	The Status attribute shall be present in the P2P IE.
P2P Capability	2	The P2P Capability attribute shall be present in the P2P IE.
Operating Channel	17	The Operating Channel attribute shall be present in the P2P IE.
Channel List	11	The Channel List attribute shall be present in the P2P IE.
P2P Group ID	15	The P2P Group ID attribute shall be present if the P2P Device sending the GO Negotiation Confirmation frame will become P2P Group Owner following Group Owner Negotiation.

4.2.9.5 P2P Invitation Request frame

The P2P Invitation Request frame uses the P2P public action frame format.

The Dialog Token field is set to a nonzero value chosen by the P2P Device sending the P2P Initiation Request frame to identify the request/response transaction.

The Elements field in the P2P Invitation Request frame contains a P2P IE and may contain a WSC IE. P2P attributes for a P2P IE that is present in the P2P Invitation Request frame are shown in Table 67.

Table 67—P2P attributes in the P2P Invitation Request frame

Attributes	Attribute ID	Note
Configuration Timeout	5	The Configuration Timeout attribute shall be present in the P2P IE.
Invitation Flags	18	The Invitation Flags attribute shall be present in the P2P IE.
Operating Channel	17	The Operating Channel attribute shall be present in the P2P IE if the P2P Invitation Request frame is transmitted by the P2P Group Owner. The Operating Channel attribute may be present in the P2P IE if the P2P Invitation Request frame is transmitted by a P2P Client.
P2P Group BSSID	7	The P2P Group BSSID attribute shall be present in the P2P IE if the P2P Invitation Request frame is transmitted by the P2P Group Owner or by a P2P Client if the Invitation Type in the Invitation Flags attribute is 0, indicating a P2P Invitation Request to join an active P2P Group.
Channel List	11	The Channel List attribute shall be present in the P2P IE.
P2P Group ID	15	The P2P Group ID attribute shall be present in the P2P IE.
P2P Device Info	13	The P2P Device Info attribute shall be present in the P2P IE.

If an NFC Static Handover occurs between a P2P Device with NFC Tag and a P2P Device which supports NFC Interface, the WSC IE may be included in the P2P Invitation Request frame. In such a case, the WSC IE contains with the Device Password ID and other attributes as shown in Table 67.

The Device Password ID attribute shall be set to a value that identifies an Out-of-Band Device Password read from an NFC Tag.

Table 68—WSC IE in the P2P Invitation Request Frame

Attribute	R/O	Allowed Values
Version2 (inside Wi-Fi Alliance Vendor Extension)	R	Version 2.0 and above (0x20 = version 2.0, 0x21 = version 2.1 etc.)

Attribute	R/O	Allowed Values
Device Password ID	R	The value of Device Password ID attribute shall be set to the value read from an NFC Tag.
<other...>	O	Multiple attributes are permitted.

4.2.9.6 P2P Invitation Response frame

The P2P Invitation Response frame uses the P2P public action frame format.

The Dialog Token field is set to a nonzero value received in the P2P Invitation Request frame to identify the request/response transaction.

The Elements field in the P2P Invitation Response frame contains a P2P IE. P2P attributes for a P2P IE that is present in the P2P Invitation Response frame are shown in Table 69.

Table 69—P2P attributes in the P2P Invitation Response frame

Attributes	Attribute ID	Note
Status	0	The Status attribute shall be present in the P2P IE.
Configuration Timeout	5	The Configuration Timeout attribute shall be present in the P2P IE.
Operating Channel	17	The Operating Channel attribute shall be present in the P2P IE if the P2P Invitation Response frame is transmitted by the P2P Group Owner and the Status field is set to "Success". The Operating Channel attribute may be present in the P2P IE if the P2P Invitation Response frame is transmitted by a P2P Client.
P2P Group BSSID	7	The P2P Group BSSID attribute shall be present in the P2P IE if the P2P Invitation Response frame is transmitted by the P2P Group Owner and the Status field is set to "Success".
Channel List	11	The Channel List attribute shall be present in the P2P IE if the Status field is set to 'Success'.

4.2.9.7 Device Discoverability Request frame

The Device Discoverability Request frame uses the P2P public action frame format.

The Dialog Token field is set to a nonzero value chosen by the P2P Device sending the Device Discoverability Request frame to identify the request/response transaction.

The Elements field in the Device Discoverability Request frame contains a P2P IE. P2P attributes for a P2P IE that is present in the Device Discoverability Request frame are shown in Table 70.

Table 70—P2P attributes in the Device Discoverability Request frame

Attributes	Attribute ID	Note
P2P Device ID	3	The P2P Device ID attribute shall be present in the P2P IE.
P2P Group ID	15	The P2P Group ID attribute shall be present in the P2P IE.

4.2.9.8 Device Discoverability Response frame

The Device Discoverability Response frame uses the P2P public action frame format.

The Dialog Token field is set to a nonzero value received in the Device Discoverability Request frame to identify the request/response transaction.

The Elements field in the Device Discoverability Response frame contains a P2P IE. P2P attributes for a P2P IE that is present in the Device Discoverability Response frame are shown in Table 71

Table 71—P2P attributes in the Device Discoverability Response frame

Attributes	Attribute ID	Note
Status	0	The Status attribute shall be present in the P2P IE.

4.2.9.9 Provision Discovery Request frame

The Provision Discovery Request frame uses the P2P public action frame format.

The Dialog Token field is set to a nonzero value chosen by the P2P Device sending the Provision Discovery Request frame to identify the request/response transaction.

The Elements field in the Provision Discovery Request frame contains a P2P IE and WSC IE. P2P attributes for a P2P IE that is included in the Provision Discovery Request frame are shown in Table 72 (P2P attributes in the Provision Discovery Request frame).

Table 72—P2P attributes in the Provision Discovery Request frame

Attributes	Attribute ID	Note
P2P Capability	2	The P2P Capability attribute shall be present in the P2P IE.
P2P Device Info	13	The P2P Device Info attribute shall be present in the P2P IE.

Attributes	Attribute ID	Note
P2P Group ID	15	The P2P Group ID attribute shall be present in the P2P IE when joining an operating P2P Group.
Intended P2P Interface Address	9	The Intended P2P Interface Address attribute may be present in the P2P IE if P2Ps [10] is supported.
Status	0	The Status attribute shall be present in the P2P IE if P2Ps [10] is supported and the corresponding Provision Discovery Request is a follow-on Provision Discovery Request.
Operating Channel	17	The Operating Channel attribute may be present in the P2P IE if P2Ps [10] is supported.
Channel List	11	The Channel List attribute may be present in the P2P IE if P2Ps [10] is supported.
Session Information Data Info	22	The Session Information Data Info attribute may be present in the P2P IE if P2Ps [10] is supported.
Connection Capability Info	23	The Connection Capability Info may be present in the P2P IE if P2Ps [10] is supported.
Advertisement_ID Info	24	The Advertisement_ID Info attribute shall be present in the P2P IE if P2Ps [10] is supported.
Configuration Timeout	5	The Configuration Timeout attribute may be present in the P2P IE if P2Ps [10] is supported.
Listen Channel	6	The Listen Channel attribute may be present in the P2P IE if P2Ps [10] is supported.
Session ID Info	26	The Session ID Info attribute shall be present in the P2P IE if P2Ps [10] is supported.
Feature Capability	27	The Feature Capability attribute shall be presented in the P2P IE if P2Ps [10] is supported.
Persistent Group Info	28	The Persistent Group Info attribute may be presented in the P2P IE if P2Ps [10] is supported.

The Config Methods attribute shall be present in the WSC IE that is included in the Provision Discovery Request frame. A single method shall be set in the Config Methods attribute. The method set in the Config Methods attribute shall indicate which of the receiving P2P Device's configuration methods that the P2P Device intends to use in Provisioning. For example, if the sending P2P Device intends to use a PIN that the receiving P2P Device Displays it shall use the value 'Display'; if the sending P2P Device intends to use a PIN that the user of the receiving P2P Device enters it shall use the value 'Keypad'.

4.2.9.10 Provision Discovery Response frame

The Provision Discovery Response frame uses the P2P public action frame format.

The Dialog Token field is set to a nonzero value received in the Provision Discovery Request frame to identify the request/response transaction.

The Elements field in the Provision Discovery Response frame may contain a P2P IE and shall contain a WSC IE. A P2P IE shall be present if P2Ps [10] is supported. P2P attributes for a P2P IE that is included in the Provision Discovery Response frame are shown in Table 72 (P2P attributes in the Provision Discovery Response frame).

Table 73 - P2P attributes in the Provision Discovery Response frame

Attributes	Attribute ID	Note
Status	0	The Status attribute shall be present in the P2P IE if P2Ps [10] is supported.
P2P Capability	2	The P2P Capability attribute shall be present in the P2P IE if P2Ps [10] is supported.
P2P Device Info	13	The P2P Device Info attribute shall be present in the P2P IE if P2Ps [10] is supported.
P2P Group ID	15	The P2P Group ID attribute may be present if P2Ps [10] is supported,
Intended P2P Interface Address	9	The Intended P2P Interface Address attribute may be present in the P2P IE if P2Ps [10] is supported.
Operating Channel	17	The Operating Channel attribute may be present in the P2P IE if P2Ps [10] is supported.
Channel List	11	The Channel List attribute may be present in the P2P IE if P2Ps [10] is supported.
Connection Capability Info	23	The Connection Capability Info may be present in the P2P IE if P2Ps [10] is supported.
Advertisement ID Info	24	The Advertisement_ID Info attribute shall be present in the P2P IE if P2Ps [10] is supported.
Configuration Timeout	5	The Configuration Timeout attribute may be present in the P2P IE if P2Ps [10] is supported.
Session ID Info	26	The Session ID Info attribute shall be present in the P2P IE if P2Ps [10] is supported.
Feature Capability	27	The Feature Capability attribute shall be presented in the P2P IE if P2Ps [10] is supported.
Persistent Group Info	28	The Persistent Group Info attribute may be presented in the P2P IE if P2Ps [10] is supported.
Session Information Data Info	22	The Session Information Data Info attribute may be present in the P2P IE if P2Ps [10] is supported.

The Config Methods attribute shall be present in the WSC IE that is included in the Provision Discovery Response frame. The value of the Config Methods attribute shall be set to the same value received in the Provision Discovery

Request frame to indicate success or shall be null to indicate failure of the request.

4.2.10 P2P action frames

4.2.10.1 General format

The Vendor Specific action frame format (as defined in IEEE 802.11-2020 [1]) is used to define the P2P action frames in this specification. The general format of the P2P action frames is shown in Table 74.

The Notice of Absence, P2P Presence Request, and P2P Presence Response frames shall not be transmitted when operating within DMG.

Table 74—General format of P2P action frame

Field	Size (octets)	Value (Hexadecimal)	Description
Category	1	0x7F	IEEE 802.11 vendor specific usage (IEEE 802.11-2020 [1] Table 9-51).
OUI	3	50 6F 9A	Wi-Fi Alliance specific OUI.
OUI type	1	0x09 (to be assigned)	Identifying the type or version of action frame. Setting to 09 indicates Wi-Fi Direct v1.0.
OUI Subtype	1		Identifying the type of P2P action frame. The specific value is defined in Table 75.
Dialog Token	1		When set to a nonzero value, used to identify the request/response transaction.
Elements	variable		Including P2P IE or any information elements defined in IEEE 802.11-2020 [1].

Table 75—P2P action frame type

Type	Notes
0	Notice of Absence
1	P2P Presence Request
2	P2P Presence Response
3	GO Discoverability Request
4 – 255	Reserved



4.2.10.2 Notice of Absence frame

The Notice of Absence P2P action frame uses the P2P Specific Action frame format and may be transmitted by a P2P Group Owner to advertise a Notice of Absence schedule.

The Dialog Token field in a Notice of Absence P2P action frame shall be set to 0 on transmission and ignored on reception.

The Elements field in a Notice of Absence action frame shall contain a P2P IE with a single Notice of Absence attribute.

4.2.10.3 P2P Presence Request frame

The P2P Presence Request action frame uses the P2P Action frame format and may be transmitted by a P2P Client to influence P2P Group Owner power management timing.

The Dialog Token field in a Client P2P action frame shall be set to a non-zero value selected by the P2P Client to identify the P2P Presence Request-Response transaction.

The Elements field in a P2P Presence Request action frame shall contain a P2P IE with a single Notice of Absence attribute describing the requested P2P Group Owner presence timing, see Section 3.3.4.4.

4.2.10.4 P2P Presence Response frame

The P2P Presence Response P2P action frame uses the P2P Action frame format and is transmitted by a P2P Group Owner in response to a P2P Presence Request frame.

The Dialog Token field in the P2P Presence Response P2P action frame shall be set to the value received in the corresponding P2P Presence Request frame.

The Elements field in a P2P Presence Response frame shall contain a P2P IE with a Status attribute, followed by one Notice of Absence attribute describing the P2P Group Owner power save timing that the P2P Group Owner will use in response to the P2P Presence Request.

4.2.10.5 GO Discoverability Request frame

The GO Discoverability Request P2P action frame uses the P2P Action frame format and is transmitted by a P2P Group Owner to a P2P Client when a P2P Device has sent the P2P Group Owner a P2P Device Discoverability Request frame.

The Dialog Token field in the GO Discoverability Request P2P action frame shall be NULL.

There is no Elements field in a GO Discoverability Request frame.

4.2.11 Service Discovery action frames

4.2.11.1 Service Discovery Query frame

The Service Discovery Query frame uses the GAS Initial Request action frame (see IEEE 802.11-2020 [1]). This section defines the structure and content of the Vendor-Specific content of this frame. Details on the complete frame construct can be found in IEEE 802.11-2020 [1]. Appendix C defines the values for GAS Initial Request frame fields.

The Vendor-Specific content field is illustrated in Table 76.

Table 76—Service Discovery Vendor-specific Content

Field Name	Size (octets)	Value	Description
OUI Subtype	1	0x09	Wi-Fi Alliance OUI Subtype
Service Update Indicator	2	variable	The Service Update Indicator is a counter that is incremented when a change has occurred in the service information of the P2P Device sending this Service Discovery Query or Response frame.
Service TLV	variable	variable	Service TLV (refer to Table 77)

The Service Request TLV (Type-Length-Value) format is defined in Table 77.

Table 77—Service Request TLV Fields

Field Name	Size (octets)	Value	Description
Length	2	variable	Length of the Service Request TLV
Service Protocol Type	1	Table 78	Service protocol types
Service Transaction ID	1	variable	Service transaction ID is a nonzero value used to match the Service Request/Response TLVs.
Query Data	variable	NA	Query data for the requested service information.

The Length is a 2-octet field whose value is equal to 2 plus the number of octets in the Query Data field.

The Service Protocol Type is a 1-octet field that shall be equal to one of the values defined in Table 78

Table 78—Service Protocol Types

Value	Meaning
0	All Service Protocol Types
1	Bonjour
2	UPnP
3	WS-Discovery
4	Display
5	WiGig Display Extension over MAC – TX
6	WiGig Display Extension over MAC – RX
7	WiGig Serial Extension over MAC – Host
8	WiGig Serial Extension over MAC – Device
9	WiGig Bus Extension over MAC
10	WiGig SD Extension over MAC
11	Peer-to-Peer services (P2Ps)
12-254	Reserved
255	Vendor Specific

The Service Transaction ID is a 1-octet field set to a nonzero value by the device sending the request. This field is used to identify the Service Request TLV.

The Query Data field value is dependent on the requested Service Protocol Type. The Query Data field shall include the service information type pertaining to the requested service protocol type. If the Service Protocol Type is vendor specific, the value of the Query Data field shall be pre-pended with the vendor's OUI.

The Bonjour services are registered in the DNS SRV (RFC 2782) Service Types website (<http://www.dns-sd.org/ServiceTypes.html>).

The UPnP services are registered in the Universal Plug and Play Forum website (<http://www.upnp.org>).

Web Services Dynamic Discovery (WS-Discovery) is specified in [6].

The WiGig Display Extension, WiGig Bus Extension, and WiGig SD Extension services are defined at Wi-Fi Alliance (www.wi-fi.org). WiGig Serial Extension services are defined at USB Forum (www.usb.org).

4.2.11.2 Service Discovery Response frame

The Service Discovery Response uses the GAS Initial Response action frame. This section defines the structure and content of the Vendor-Specific content of

this frame. Details on the complete frame construct can be found in IEEE 802.11-2020 [1]. Appendix C defines the values for GAS Initial Response frame fields.

The Vendor-Specific content field is illustrated in Table 76.

The Service Response TLV (Type-Length-Value) format is defined in Table 79.

Table 79—Service Response TLV Fields

Field Name	Size (octets)	Value (Hexadecimal)	Description
Length	2	variable	Length of the Service Response TLV
Service Protocol Type	1	Table 78	Service protocol types
Service Transaction ID	1	variable	Service transaction ID is a nonzero value used to match the Service Request/Response TLVs.
Status Code	1	Table 80	Status code for the requested service information.
Response Data	variable	NA	Response Data is dependent on the requested service information type in the Query Data field of the Service Request.

The Length is a 2-octet field whose value is equal to 3 plus the number of octets in the Response Data field.

The Service Protocol Type is a 1-octet field that shall be equal to one of the values defined in Table 78.

The Service Transaction ID is a 1-octet field set to the Service Transaction ID value in the corresponding Service Request TLV.

The Status Code is a 1-octet field that shall be equal to one of the values defined in Table 80.

Table 80—Service Discovery Status Codes

Value	Meaning
0	Success
1	Service Protocol Type not available
2	Requested information not available
3	Bad Request
4–255	Reserved

The value of the Response Data field is dependent on the requested Service Protocol Type and the service information type encoded in the Query Data field.

The value of the Response Data field shall contain the requested service information type and relevant service data. If the Service Protocol Type is vendor specific, the value of the Response Data field shall be pre-pended with the vendor's OUI.

4.2.12 FST action frames

4.2.12.1 FST Setup Request and FST Setup Response frames

A P2P Device shall include a P2P IE in each transmitted FST Setup Request and FST Setup Response frames. The P2P IE shall be included after other information elements in the frame.

The P2P attributes for a P2P IE that are included in an FST Setup Request and FST Setup Response frames are shown in Table 81. All P2P attributes included in these frames correspond to the frequency band and channel specified in the Multi-band element contained in the frame carrying the P2P IE. The P2P Group BSSID and P2P Group ID attributes are not included in the P2P IE. However, their corresponding fields are specified as part of the Multi-band element that is contained in the frame carrying the P2P IE.

Table 81—P2P attributes in FST Setup Request and FST Setup Response frames

Attributes	Attribute ID	Note
P2P Capability	2	The P2P Capability attribute shall be present in the P2P IE.

4.3 DMG Frames

4.3.1 DMG Beacon and Announce frame format

A P2P Device may transmit one or more P2P IEs and the WSC IE within all DMG Beacon frames transmitted in a BTI. In addition, a P2P Device shall transmit one or more P2P IEs and the WSC IE within all Announce frames transmitted in an ATI. In both cases, these IEs shall be included after other information elements in the frame.

The P2P attributes for a P2P IE that are included in a DMG Beacon and Announce frames are shown in Table 82.

Table 82—P2P attributes in the DMG Beacon and Announce frames

Attributes	Attribute ID	Note
P2P Capability	2	The P2P Capability attribute shall be present in the P2P IE if the P2P IE is included in the frame.
P2P Device ID	3	The P2P Device ID attribute shall be present in the P2P IE if the P2P IE is included in the frame.

4.3.2 Information request frame format

Information Request frames can be transmitted by any P2P Device according to the rules specified in IEEE 802.11-2020 [1].

One or more P2P IEs and the WSC IE shall be inserted after other information elements in Information Request frames transmitted by a P2P Device as shown in Table 83.

Table 83—Information Request frame format

Order	Information Element	Note
	WSC IE	The WSC IE shall be present in the frames transmitted by a P2P Device.
Last	P2P IE	The P2P IE shall be present in the frames transmitted by a P2P Device.

Table 84 lists the additional WSC IE attributes for the Information Request frame.

Table 84—Additional WSC IE attributes for the Information Request frame

Attributes	Required/Optional	Note
Device Name	Required	The Device Name attribute shall be present in WSC IE in the Information Request frame that is transmitted by a P2P Device.
Requested Device Type	Optional	The Requested Device Type attribute may be present in WSC IE in the Information Request frame that is transmitted by a P2P Device.

Table 85 lists the P2P IE attributes for the Information Request frame.

Table 85—P2P IE attributes for the Information Request frame

Attributes	Attribute ID	Note
P2P Capability	2	The P2P Capability attribute shall be present in the P2P IE.
P2P Device ID	3	The P2P Device ID attribute may be present in the Information Request frame to find a P2P Device with a specific Device Address.
Listen Channel	6	The Listen Channel attribute shall be present in the P2P IE to indicate the operating class and channel number of the P2P Device when it is in the Listen State. If the P2P Device has not selected a Listen Channel, the Listen Channel attribute shall be omitted.

Attributes	Attribute ID	Note
Extended Listen Timing	8	The Extended Listen Timing attribute may be present in the P2P IE to advertise Listen State availability of the P2P Device sending the Information Request.
Operating Channel	17	The Operating Channel attribute shall only be present in the P2P IE if the P2P Device is an operating P2P Group Owner and indicates the operating class and channel number on which the P2P Device is operating as P2P Group Owner.

4.3.3 Information response frame format

Information Response frames may be transmitted by any P2P Device according to the rules specified in IEEE 802.11-2020 [1].

Information Response frames may be transmitted by a P2P Device either in its Operating Channel or Listen Channel.

One or more P2P IEs and WSC IEs shall be inserted after other information elements in Information Response frames transmitted by a P2P Device. Table 86 lists the P2P IE attributes for the Information Response frame.

Table 86—P2P IE attributes for the Information Response frame

Attributes	Attribute ID	Note
P2P Capability	2	The P2P Capability attribute shall be present in the P2P IE.
Extended Listen Timing	8	The Extended Listen Timing attribute may be present in the P2P IE to advertise Listen State availability of the P2P Device sending the Information Response.
P2P Device Info	13	The P2P Device Info attribute shall be present in the P2P IE to indicate the P2P Device information.
P2P Group Info	14	The P2P Group Info attribute shall only be present in the P2P IE in the Information Response frame that is transmitted by a P2P Group Owner. The P2P Group Info attribute shall be omitted if there are zero connected P2P Clients.

4.4 Frame Usage

Table 87 shows which frame subtypes are transmitted and received by a P2P Group Owner, P2P Client or P2P Device during P2P Discovery.

In Table 87, the qualifier “(non-DMG)” indicates that the corresponding frame is transmitted only when operating outside DMG. Similarly, the qualifier “(DMG)” indicates that the corresponding frame is transmitted only when operating within DMG. The absence of a qualifier allows a frame to be transmitted in any frequency band.

Table 87—Frame subtype usage

Frame Subtype	P2P Device in the Listen State	P2P Device in the Scan Phase or Search State	GO Formation Procedure	P2P Client	P2P Group Owner
Beacon (non-DMG)	—	R	—	R	T
Probe Request (non-DMG)	R	T	—	T	R
Probe Request (DMG)	R	T, R	—	T	T, R
Probe Response (non-DMG)	T	R	—	R	T
Probe Response (DMG)	T	T, R	—	R	T, R
Service Discovery Query	T, R	T, R	—	T, R	T, R
Service Discovery Response	T, R	T, R	—	T, R	T, R
P2P Invitation Request	R	T	—	T, R	T, R
P2P Invitation Response	T	R	—	T, R	T, R
GO Negotiation Request	R	R	T, R	—	—
GO Negotiation Response	—	—	T, R	—	—
GO Negotiation Confirmation	—	—	T, R	—	—
(Re)Association Request	—	—	T, R	T	R
(Re)Association Response	—	—	T, R	R	T
Notice of Absence (non-DMG)	—	—	—	R	T
P2P Presence Request (non-DMG)	—	—	—	T	R
P2P Presence Response (non-DMG)	—	—	—	R	T
Device Discoverability Request	—	T	—	—	R
Device Discoverability Response	—	R	—	—	T
GO Discoverability Request	—	—	—	R	T

Frame Subtype	P2P Device in the Listen State	P2P Device in the Scan Phase or Search State	GO Formation Procedure	P2P Client	P2P Group Owner
Provision Discovery Request	R	T	—	—	R
Provision Discovery Response	T	R	—	—	T
Discovery DMG Beacon (DMG)	R	T, R	—	R	—
Non-Discovery DMG Beacon (DMG)	R	R	—	R	T
Information Request (DMG)	T, R	T, R	—	T, R	T, R
Information Response (DMG)	T, R	T, R	—	T, R	T, R

Note: T = Transmit; R = Receive; — = not available.

4.5 NFC NDEF Structure

This section defines the NDEF Record format of the P2P Carrier Configuration Record, which is referenced by an Alternative Carrier Record embedded within a Handover Request Record in a Handover Request Message, or within a Handover Select Record in a Handover Select Message, as defined in [7]. Further details of NDEF Record format is defined in [8]. It should be noted that, while the descriptions below illustrate Handover Request and Handover Select NDEF Records that only include one Alternative Carrier, Handover Request and Handover Select records may include more than one Alternative Carrier record. Alternative Carrier records may be in any order, thus a device supporting P2P and NFC that receives a NDEF Handover Request Message or a Handover Select Message shall process all records. A device should list Multiple Alternative Carrier records in order of priority in both Handover Request and Handover Select Messages (see [7] for further details).

Note that P2P version negotiation is not practical in all cases for NFC negotiated handover or static handover. Since version negotiation is not possible, future changes to connection handover may require definition of a new MIME type and Alternative Carrier Record.

4.5.1 NFC P2P Handover Request Message

The NFC P2P Handover Request Message shall include the P2P Carrier Configuration Record as illustrated in Figure 23.

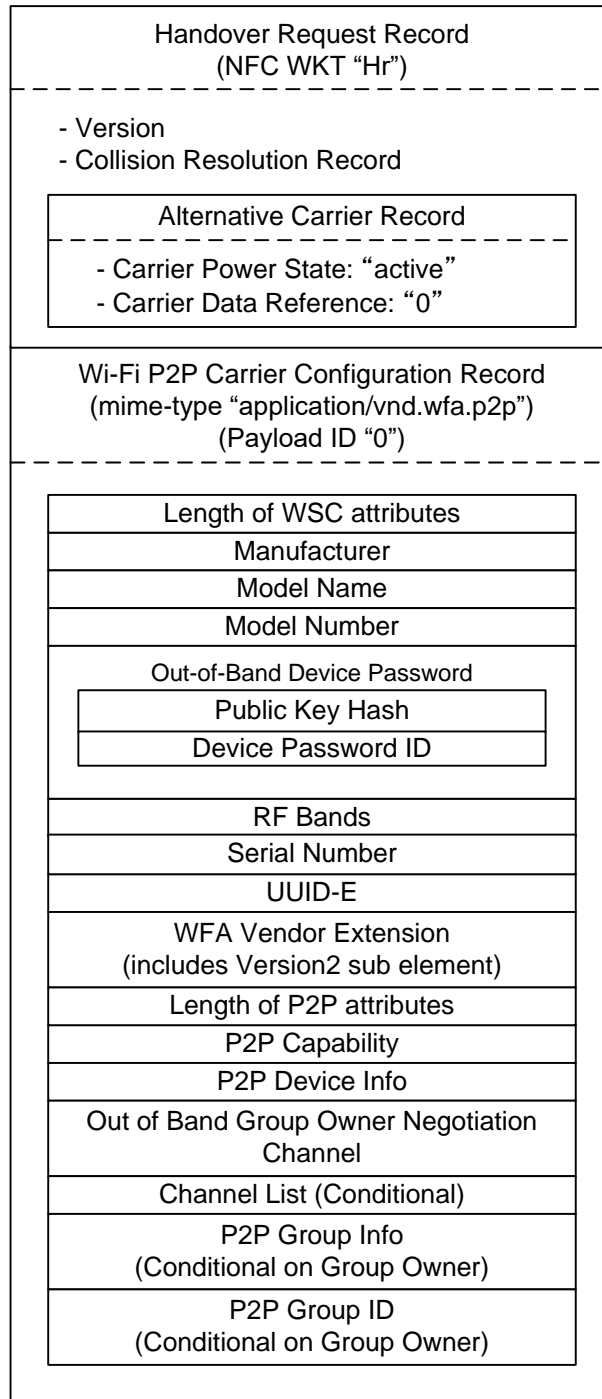

Figure 23—NFC P2P Handover Request Message

The P2P Carrier Configuration Record contains the device information used for P2P protocol. WSC attributes defined in Table 88 shall be included in the P2P Carrier Configuration Record. The overall size occupied by each mandatory WSC attribute shown in Table 88 shall include an additional 4 bytes (2 bytes of

ID, 2 bytes of length) as defined in [2]. At the head of WSC attributes the length of WSC attributes field shall be included. The size of the Length of WSC attributed field shall be 2 octets. The value held by the Length of WSC attributes field shall be the total length of the following WSC attributes in the P2P Carrier Configuration Record in octets, using big-endian byte ordering.

Table 88—Mandatory WSC attributes in the P2P Carrier Configuration Record

ID (Type)	Notes
0x1021	Manufacturer
0x1023	Model Name
0x1024	Model Number
0x102C	Out-of-Band Device Password
0x103C	RF Bands
0x1042	Serial Number
0x1047	UUID-E
0x1049	Wi-Fi Alliance Vendor Extension(includes Version2 sub element)

P2P attributes defined in Table 89 shall be included in the P2P Carrier Configuration Record. The overall size occupied by each P2P attribute shown in Table 89 shall include an additional 3 bytes (1 byte of ID, 2 bytes of Length). At the head of P2P attributes the Length of P2P attributes shall be included. The size of the Length of P2P attributes field shall be 2 octets. The value held by the Length of P2P attributes field shall be the total length of the following P2P attributes in the P2P Carrier Configuration Record in octets, big-endian byte ordering.

Table 89—P2P attributes in the P2P Carrier Configuration Record

ID (Type)	Notes	Category
2	P2P Capability	Mandatory
13	P2P Device Info	Mandatory
19	Out-of-Band Group Owner Negotiation Channel	Mandatory
11	Channel List	Conditional
14	P2P Group Info	Conditional
15	P2P Group ID	Conditional

Devices which cannot provide a preferred operating class or channel number for Out-of-Band Group Owner Negotiation shall also include the Channel List attribute to be used for a full channel search. The unavailability of an operating class or channel number shall be indicated in the Out-of-Band Group Owner Negotiation attribute as defined in 4.1.21.

A Group Owner shall also include the P2P Group Info attribute, if it has at least one P2P client, and the P2P Group ID attribute in the P2P Carrier Configuration Record.

If the P2P Group Info attribute will not fit into the handover message, for example due to the number of P2P Client Info Descriptors versus the available memory, then the number of included P2P Client Info Descriptors shall be reduced, and the length of the P2P Group Info attribute adjusted accordingly, to fit the available memory size of the NFC Tag. The selection of which P2P Client Info Descriptors to include is an implementation decision. P2P Client Info Descriptors shall not be truncated.

For a device that is currently part of a Group, the channel indicated by the Out-of-Band Group Owner Negotiation Channel attribute shall be the Group's current operating channel. For a device that is not currently part of a Group, the channel shall be the device's Listen Channel.

4.5.2 NFC P2P Handover Select Message

The NFC P2P Handover Select Message shall include the P2P Carrier Configuration Record as illustrated in Figure 24.

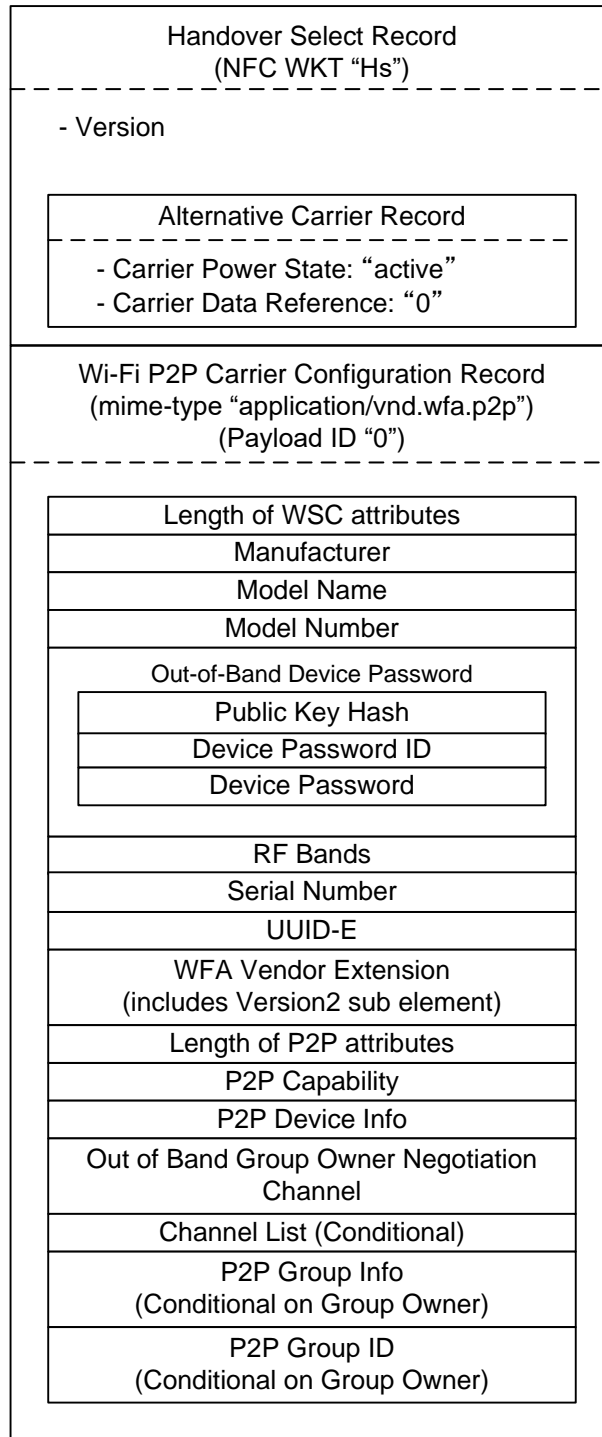

Figure 24—NFC P2P Handover Select Message

The P2P Carrier Configuration Record contains the device information used for P2P protocol. WSC attributes defined in Table 88 shall be included in the P2P Carrier Configuration Record.

When negotiated handover is in use the Device Password shall have zero length. The WSC exchange over 802.11 that follows negotiated handover finishes after provision of WLAN credentials in WSC message M2. When static handover is in use the Device Password shall have non-zero length. The WSC exchange over 802.11 that follows static handover finishes after provision of WLAN credentials in WSC message M8.

The overall size occupied by each mandatory WSC attribute shown in Table 88 shall include an additional 4 bytes (2 bytes of ID, 2 bytes of Length) as defined in [2]. At the head of WSC attributes the Length of WSC attributes field shall be included. The size of the Length of WSC attributes field shall be 2 octets. The value held by the Length of WSC attributes field shall be the total length of the following WSC attributes in the P2P Carrier Configuration Record in octets, using big-endian byte ordering.

P2P attributes defined in Table 89 shall be included in the P2P Carrier Configuration Record. The overall size occupied by each P2P attribute shown in Table 89 shall include an additional 3 bytes (1 byte of ID, 2 bytes of Length). At the head of P2P attributes the Length of P2P attributes shall be included. The size of the Length of P2P attributes field shall be 2 octets. The value held by the Length of P2P attributes field shall be the total length of the following P2P attributes in the P2P Carrier Configuration Record in octets, big-endian byte ordering.

Devices that cannot provide a preferred operating class or channel number for Out-of-Band Group Owner negotiation shall include the Channel List attribute to be used for a full channel search. The unavailability of an operating class or channel number shall be indicated in the Out-of-Band Group Owner negotiation attribute as defined in 4.1.21.

A Group Owner shall include the P2P Group ID attribute in the P2P Carrier Configuration Record. If a Group Owner has an NFC Interface and has at least one P2P client, then it shall include the P2P Group Info attribute in the P2P Carrier Configuration Record. If a Group Owner has an NFC Tag, does not have NFC Interface and has at least one P2P client, then it may include the P2P Group Info attribute in the P2P Carrier Configuration Record.

If the P2P Group Info attribute will not fit into the handover message, for example due to the number of P2P Client Info Descriptors versus the available memory on an NFC Tag, then the number of included P2P Client Info Descriptors shall be reduced, and the length of the P2P Group Info attribute adjusted accordingly, to fit the available memory size. A Group Owner shall not truncate P2P Client Info Descriptors and the selection of which P2P Client Info Descriptors to include is an implementation decision. .

If a device is currently part of a Group, then the device shall set the channel indicated by the Out-of-Band Group Owner Negotiation Channel attribute to the Group's current operating channel. For a device that is not currently part of a Group the channel shall be the device's Listen Channel.

Appendix A P2P State Machine

This Appendix is for informational purposes. It is intended to illustrate the various states and phases defined in the specification and possible transitions between them. The informative diagram of the P2P State Machine is illustrated in Figure A1. It depicts a number of common transitions, and it is neither meant to represent any particular implementation nor meant to be exhaustive of all possible protocol uses. The explanatory text identifies some additional possible transitions, and it is also not meant to be exhaustive.

In this appendix, the following remarks apply when the discovery takes place within DMG:

- Message exchanges related to the DMG beamforming procedure are omitted.
- Authentication frames are not transmitted.
- The term “beacon” or “Beacon” refers to the DMG Beacon frame.

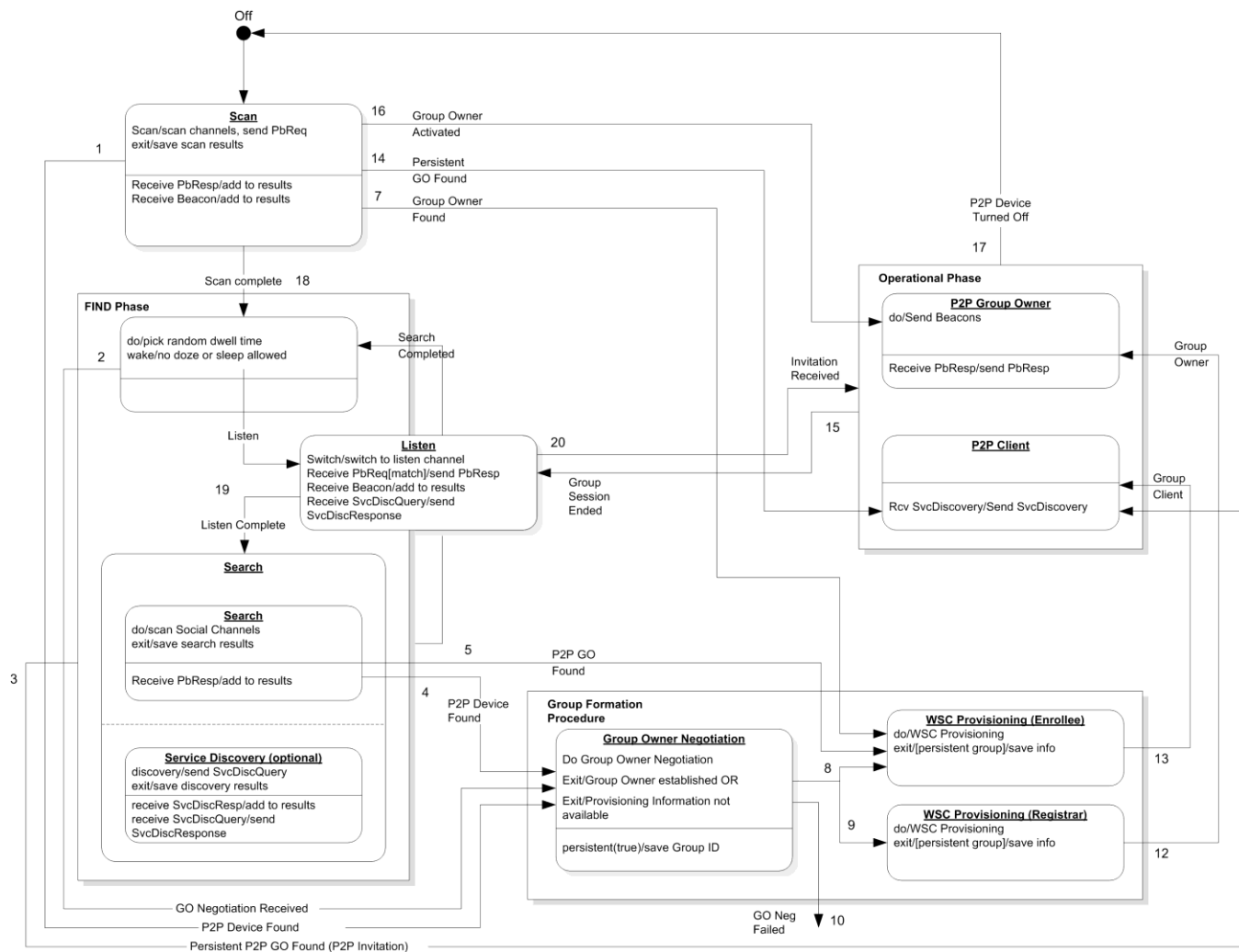

Figure A1—P2P State Machine

Scan Phase

State: Scan

Actions:

- **Scan**
This action includes scanning all – or a subset of all - supported channels, including possibly passive scanning of certain 5 GHz bands. Active scanning is performed by sending Probe Request frames with the P2P IE. Optionally the Probe Request carries information about the type or Device Address of the device that it is asking to respond.
- **Exit**
This action stores the gathered information for use while in Find phase, or directly for use in the Group Owner Negotiation and Provisioning phase or Operational phase

Internal Behavior:

- *Receive Probe Response*
When a Probe Response message is received, the pertinent information (e.g. Device Name, Device Type, Operating Channel, P2P IE, P2P Device Address – of the Group Owner and all P2P Clients in its Group) is stored for later use and the Scan action is continued.
- *Receive Beacon*
When a Beacon is received, the pertinent information (e.g. Channel, P2P IE) is stored for later use and the Scan action is continued.

Transitions:

- *(1) P2P Device found.*
When another P2P Device is found, the P2P Device may transition to the Group Owner Negotiation and Provisioning phase to negotiate P2P Group ownership.
- *(7) P2P Group Owner found.*
When a P2P Group Owner is found, the P2P Device may transition directly to the Provisioning state – if not yet provisioned – or to the Operational state. Note that this would be similar to the flow of a Legacy Client.
- *(14) P2P Group Owner of a previously connected persistent group found.*
When a P2P Device is found which is the Group Owner of a persistent group, the discovering device may send a P2P Invitation. When accepted, the P2P Device shall transition to the Operational phase.
- *(16) Group Owner functionality activated.*
An active P2P Group Owner may send out beacons, even with no other devices connected.
- *(18) Scan Complete.*
When the scan is completed, the Device may transition to the Find phase.

Find Phase*State: Listen**Actions:*

- *Pick Random Dwell Time*
On entering the Listen state, the P2P Device chooses a random dwell between minDiscoverableInterval and maxDiscoverableInterval (the default values for these are 1 and 3 times 100TU respectively).
- *Listen on Social Channel*
The P2P Device listens on the chosen Social Channel for the chosen dwell time.

Internal Behavior:

- *Receive Probe Request with matching parameters*
When a Probe Request with matching parameters (e.g. P2P IE, P2P Wildcard SSID, Requested Device Type, P2P Device ID) is received, a Probe Response message is sent.
- *Receive Beacon*
When a Beacon is received, the pertinent information (e.g. Channel, P2P IE) is stored for later use and the Listen action is continued.
- *Receive Service Discovery Query*
When a Service Discovery query message is received, and Service Discovery is supported, a Service Discovery Response message is sent.

Transitions:

- *(2) Group Owner Negotiation Received.*
When the P2P Device receives a Group Owner Negotiation message, it shall transition to the Group Formation phase.
- *(19) Listen State Completed.*
When either the chosen random dwell time has passed, or some other (e.g. higher layer or user level) action terminates the Listen State, the P2P Device shall transition to the Search composite state.
- *(20)*
If a P2P Device that is a member of a persistent group is in the listen phase, it may receive a P2P Invitation Request from a previously provisioned P2P Client or Group Owner. In that case it may transition to the Operational phase.
- *(Other)*
A P2P Device may also receive an Invitation Request to join a P2P Group that it has not stored credentials for. In that case it may transition to the WSC Provisioning Enrollee state of the Group Formation procedure.

Composite State: Search

Sub-State: Search

Actions:

- *Scan Social Channels*
Send Probe Request messages on Social Channels only. Note that the Probe Request message may include either a specific Requested Device Type being searched for, or a P2P Device ID. In the first case, P2P Devices that receive a Probe Request with a Requested Device Type that does not match their own or (in the case that the P2P Device is a Group owner) of that of their Clients should not respond with a Probe Response message. In the second case, P2P Devices that receive a Probe Request with a P2P Device ID containing a Device Address that does not match their own or (in

the case that the P2P Device is a Group owner) of that of their Clients should not respond with a Probe Response message.

- *Exit*

This action stores the gathered information from the Search state for later use.

Internal Behavior:

- *Receive Probe Response*

When a Probe Response message is received, the pertinent information (e.g. Device Name, Device Type, Operating Channel, P2P IE, P2P Device Address – of the Group Owner and all P2P Clients in its Group) is stored for later use and the Search action is continued.

Sub-State: Service Discovery (optional)

Actions:

- *Discovery*

Send Service Discovery Request messages to previously found P2P Devices that have indicated support for Service Discovery functionality.

- *Exit*

This action stores the gathered information from the Service Discovery state for later use.

Internal Behavior:

- *Receive Service Discovery Response*

When a Service Discovery Response message is received, the pertinent information (e.g. Service Name, Service Information) is stored for later use and the Discovery action is continued.

Transitions:

- (3) *Persistent P2P Group Owner Found.*

When a persistent P2P Group Owner is found, for which credentials have been provisioned previously, the P2P Device may send a P2P Invitation. If accepted, the P2P Device may transition to the Operational phase.

- (6) *Search State Completed.*

When all Social Channels have been scanned, and no other transition has been initiated, the P2P Device may transition back to the Listen state of the Find phase.

- (4) *P2P Device Found.*

When another P2P Device is found, the device may move to the Group Formation Procedure.

- (5) *P2P Group Owner Found.*

When a P2P Group Owner is found, the device may transition to the WSC Provisioning Enrollee state – if not yet provisioned – or to the Operational phase. Note that it is also allowed to transition to

the Group Formation procedure, to negotiate a new (possibly concurrent) P2P Group.

- *(Other)*
When no other P2P Device can be found, the P2P Device may transition back to the Scan phase. Note that an active Group Owner may operate on any channel and has no requirement to listen on a social channel. Therefore it may be that it can only be found during the Scan phase. Note also that as a Group Owner may be in Power Save, it may be hard to find during a short scan of a channel.

Group Formation Procedure

State: Group Owner Negotiation

Actions:

- *Group Owner Negotiation*
The P2P Device either initiates Group Formation, or responds to the Group Owner Negotiation request message received from another P2P Device.
- *Exit*
At the end of the negotiation both parties are in agreement of who is the P2P Group Owner and who is the P2P Client, OR the negotiation fails. Negotiation will fail immediately if provisioning information is not (yet) available on both sides.

Internal Behavior:

- *Persistent*
If during the Group Formation it is established that this is to be a persistent P2P Group, pertinent information (e.g. Device MAC Address, P2P Group ID) is stored for later use

Transitions:

- *(9) P2P Device becomes Group Owner.*
When the P2P Device becomes Group Owner in the Negotiation state, it may transition to the WSC Provisioning Registrar state to establish WSC credentials with the Client.
- *(8) P2P Group becomes Client.*
When the P2P Device becomes a Client in the Negotiation phase, it may transition to the WSC Provisioning Enrollee state to establish WSC credentials with the Group Owner.
- *(10) Group Owner Negotiation fails.*
When Group Owner Negotiation fails for some reason the P2P Device may transition to the Scan or Search Phase, or may seek additional user level input. If the Group Owner Negotiation fails due to Provisioning Information not being available, either P2P Device may try entering Group Owner Negotiation again at a later time.

State: WSC Provisioning Enrollee

Actions:

- *WSC Provisioning*
This action includes the whole WSC provisioning process in the role of Enrollee. It is assumed that user level input such as a PIN is already available when Group Owner Negotiation takes place.
- *Exit*
When WSC provisioning is completed, and if this is a persistent P2P Group, the credentials for this group are stored for later use.

Internal Behavior: None

Transitions:

- *(13) WSC Provisioning Completed.*
When WSC Provisioning is completed the P2P Device may transition to the Operational phase.
- *(Other)*
Note that it is possible that WSC provisioning fails, in which case the P2P Device may transition to:
 - Scan phase (if the P2P Device is not a Group Owner of a persistent group)
 - Operational phase (if it is a Group Owner of an active persistent group)
 - Listen state (if it is a Group Owner of one or more persistent groups that are not currently active)
 - It may restart Group Formation with a different P2P Device.Note that these transitions are not explicitly included in the state diagram.

State: WSC Provisioning Registrar

Actions:

- *WSC Provisioning*
This action includes the whole WSC provisioning process in the role of Registrar. It is assumed that user level input such as a PIN is already available when Group Owner Negotiation takes place.
- *Exit*
When WSC provisioning is completed, and if this is a persistent P2P Group, the credentials for this group are stored for later use.

Internal Behavior: None

Transitions:

- *(12) WSC Provisioning Completed.*
When WSC Provisioning is completed the P2P Device may transition to the Operational phase.
- *(Other)*
Note that it is possible that WSC provisioning fails, in which case the P2P Device may transition to:



- Scan phase (if the P2P Device is not a Group Owner of a persistent group)
- Operational phase (if it is a Group Owner of an active persistent group)
- “Permanent” Listen state (if it is a Group Owner of one or more persistent groups that are not currently active)
- It may restart the Group Formation phase with a different P2P Device.

Note that these transitions are not explicitly included in the state diagram.

Operational Phase

State: P2P Group Owner

Actions:

- *Send Beacons*
The P2P Group Owner shall send Beacon frames.

Internal Behavior:

- *Receive Probe Request*
When a Probe Request message is received, and (if present in a Probe Request that also carries the P2P IE) the Device Type matches the type of the Group Owner or any of the associated P2P Clients, it shall respond with a Probe Response message.

Transitions:

- *(17) P2P Device Turned Off*
When the P2P Device is turned off, it returns to the Off state.
- *(15) P2P Group Session Ended*
When the P2P Group session ends, i.e. there are no other P2P Devices associated with the group, the P2P Device may transition to the Listen state. Note that the P2P Device may remain in the Listen State indefinitely, and it may also alternate listening with periods of sleep. The P2P Device may also transition to the Scan phase, or to the Search phase and of course it may transition to the Off state.

State: P2P Client

Actions: None

Internal Behavior:

- *Receive Service Discovery Request*
When a Service Discovery Request is received, and Service Discovery is supported by the P2P Device, it shall send a P2P Service Discovery Response message.

Transitions:

- *(17) P2P Device Turned Off*
When the P2P Device is turned off, it returns to the Off state.



- *(15) P2P Group Dissolved*
When the P2P Group session ends, i.e. there are no other P2P Devices associated with the group, the P2P Device may transition to the Scan phase. Alternatively it may transition to the Listen state.

Appendix B P2P Specific WSC IE Attributes

B.1 Requested Device Type

The Requested Device Type attribute is a P2P specific WSC IE attribute that has been added to the WSC IE in the Probe Request frame (see Section 8.2.4, Table 6 “Attributes in the WSC IE in the Probe Request frame”, of the Wi-Fi Protected Setup Specification [2]). The Requested Device Type attribute is optionally present in the WSC IE in the Probe Request frame.

Attribute	Required/Optional	Notes
Requested Device Type	Optional	

The Requested Device Type attribute has been added to Table 28 (Attribute types and sizes) in Section 12 (Data Element Definitions) of the Wi-Fi Protected Setup Specification [2]:

Description	ID (Type)	Length
Requested Device Type	0x106A	8B

The following text has been added to the list of data elements definitions in Section 12 (Data Element Definitions) of the Wi-Fi Protected Setup Specification [2].

Requested Device Type

This attribute contains the requested device type of a device.

This attribute allows a device to specify the Primary Device Type or the Secondary Device Type of other devices it is interested in. Only a device that receives a Probe Request containing a WSC IE with this attribute and with a Primary Device Type or Secondary Device Type that matches the Requested Device Type will respond with a Probe Response.

Its format and contents is identical to the ‘Primary Device Type’ attribute as defined in the Wi-Fi Protected Setup Specification [2]

Both the Category ID and Sub Category ID can be used as a filter. If only looking for devices with a certain Category ID, the OUI and Sub Category ID fields will have to be set to zero.



B.2 Primary Device Type

The Primary Device Type attribute contains the primary type of the device. Its format is defined as follows:

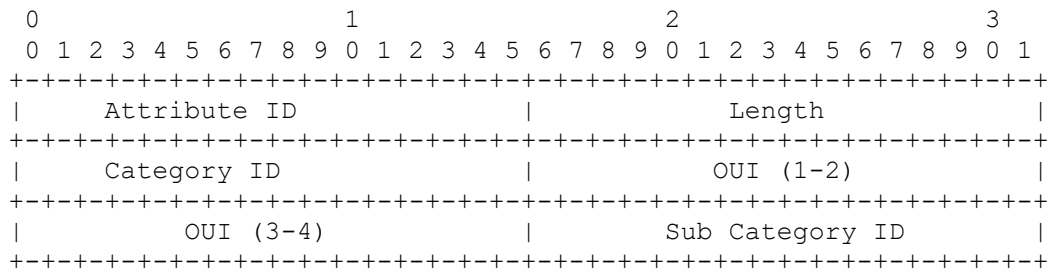

Vendor-specific sub-categories are designated by setting the OUI to the value associated with that vendor. Note that a four-byte subdivided OUI is used. For the predefined values, the Wi-Fi Alliance OUI of 00 50 F2 04 is used. The predefined values for Category ID and Sub Category ID are provided in Table 41 (Primary Device Type) in Section 12 (Data Element Definitions) of the Wi-Fi Protected Setup Specification [2]. There is no way to indicate a vendor-specific main device category. The OUI applies only to the interpretation of the Sub Category. If a vendor does not use sub categories for their OUI, the three-byte OUI occupies the first three bytes of the OUI field and the fourth byte is set to zero.

Appendix C GAS Frame Field Value

C.1 GAS Initial Request action frame

The format of the GAS Initial Request frame is defined in IEEE 802.11-2020 [1]. This section defines the values that should be used for this frame. Figure C1 illustrates the GAS Initial Request Action Frame Format and its fields.

GAS Initial Request Action Frame					
Category	Action	Dialog Token	Advertisement Protocol IE	Query Request Length	Query Request
4	10	Token ID	See below	Length	See below
1 octet	1 octet	1 octet	variable	2 octets	variable

Figure C1—GAS Initial Request Action Frame Format

The Category field is set to a value of 4, indicating Public Action Frame.

The Action field is set to a value of 10 for a GAS Initial Request Action Frame.

The Dialog Token is defined in Section 9.4.1.12 of IEEE 802.11-2020 [1] and set by the requesting P2P Device.

Figure C2 illustrates the Advertisement Protocol IE subfield.

Advertisement Protocol Information Element				
Element ID	Length	Advertisement Protocol Tuple		
108	Length	Query Response Length Limit	PAME-BI	Advertisement Protocol ID
		0000000	0	0
1 octet	1 octet	7 bits	1 bit	1 octet

Figure C2—Advertisement Protocol Information Element

The Advertisement Protocol Information Element (IE) is defined in Section 9.4.2.92 in IEEE 802.11-2020 [1]. The Advertisement Protocol element has Element ID 108 (refer to Section 9.4.2 in IEEE 802.11-2020 [1]), a Length field with value 2 and includes exactly one Advertisement Protocol Tuple.

The Advertisement Protocol Tuple is defined in Figure 9-486- in IEEE 802.11-2020 [1]. The Query Response Length Limit shall be set to 0 (bits 0 – 6). The Pre-Associated Message Exchange BSSID Independent (PAME-BI) bit



shall be set to 0 (bit 7). The Advertisement Protocol ID field shall be equal to 0, Access Network Query Protocol (ANQP).

The Query Request Length field is the total number of octets in the Query Request field.

The Query Request field is a variable container that is illustrated in Figure C3.

ANQP Query Request Field			
Info ID	Length	OI	Vendor-Specific Content
56797	Length	50 6F 9A	See below
2 octet	2 octets	3 octets	variable

Figure C3—ANQP Query Request Field

The Info ID field is set to 56797, which is the value corresponding to the Access Network Query Protocol (ANQP) vendor-specific list.

The Length is a 2-octet field whose value is equal to 3 plus the number of octets in the Vendor-Specific content field.

The OI field shall be equal to 0x50 6F 9A (Wi-Fi Alliance OUI).

Figure C4 illustrates the Vendor-specific content of the ANQP Query Request Frame.

ANQP Query Request Vendor-specific Content					
OUI Subtype	Service Update Indicator	ANQP Query Request Vendor-Specific Content TLV			
		Length	Service Protocol Type	Service Transaction ID	Query Data
9	See below	Length	Table 78	Transaction ID	See below
1 octet	2 octets	2 octets	1 octet	1 octet	variable

Figure C4—ANQP Query Request Frame Vendor-specific Content

The OUI Subtype is a 1-octet field and is set to 9.

The Service Update Indicator is a counter that is incremented when a change has occurred in the service information of the P2P Device sending this Query Request frame. See Section 3.1.3.1.

The Length is a 2-octet field whose value is equal to 2 plus the number of octets in the Query Data field.

The Service Protocol Type is a 1-octet field set to the corresponding value in Table 78.



The Service Transaction ID is a 1-octet field.

The Query Data is a variable container based on the requested Service Protocol Type.

The Length, Service Protocol Type, Service Transaction ID and Query Data fields form a TLV structure. There may one or more such TLV structures in the Vendor-specific Content field of the ANQP Query Request frame.

C.2 GAS Initial Response Action Frame

The format of the GAS Initial Response frame is defined in IEEE 802.11-2020 [1]. This section defines the values that should be used for this frame. Figure C5 illustrates the GAS Initial Response Action Frame Format and its fields.

GAS Initial Response Action Frame							
Category	Action	Dialog Token	Status Code	GAS Comeback Delay	Advertisement Protocol IE	Query Response Length	Query Response
4	11	Token ID	Table 7-23	See below	See below	Length	See below
1 octet	1 octet	1 octet	2 octets	2 octets	variable	2 octets	variable

Figure C5—GAS Initial Response Action Frame Format

The Category field is set to a value of 4 indicating Public Action Frame.

The Action field is set to a value of 11 for a GAS Initial Response Action Frame.

The Dialog Token is copied from the corresponding GAS Initial Request Action frame.

The Status Code values are defined in Table 9-50 of IEEE 802.11-2020 [1].

The GAS Comeback Delay field specifies the delay time value in TU. If the Query Response fits in a single GAS Initial Response frame, the GAS Comeback Delay field shall be set to zero. If the Query Response does not fit in a single GAS Initial Response frame, the GAS Comeback Delay field shall be set to one and the Query Response Length field shall be set to zero, indicating that GAS fragmentation will be used (refer to Section C.3 for information on GAS fragmentation).

Figure C6 illustrates the Advertisement Protocol IE subfield.



Advertisement Protocol Information Element				
Element ID	Length	Advertisement Protocol Tuple		
108	Length	Query Response Length Limit	PAME-BI	Advertisement Protocol ID
		1111111	0	0
1 octet	1 octet	7 bits	1 bit	1 octet

Figure C6—Advertisement Protocol Information Element

The Advertisement Protocol Information Element (IE) is defined in Section 9.4.2.92 in IEEE 802.11-2020 [1]. The Advertisement Protocol element includes exactly one Advertisement Protocol ID where the Element ID field is set to 108 (refer to Section 9.4.2 in IEEE 802.11-2020 [1]). The Length is a one-octet field whose value is equal to 2.

The Advertisement Protocol Tuple is defined in Figure 9-486 in IEEE 802.11-2020 [1]. The Query Response Length Limit shall be set to 127 (bits 0 – 6). The Pre-Associated Message Exchange BSSID Independent (PAME-BI) bit shall be set to 0 (bit 7). The Advertisement Protocol ID field shall be equal to 0, Access Network Query Protocol (ANQP).

The Query Response Length field is the total number of octets in the Query Response field.

The Query Response field is a variable container as defined in Figure C7.

ANQP Query Response Field			
Info ID	Length	OI	Vendor-Specific Content
56797	variable	50 6F 9A	See below
2 octets	2 octets	3 octets	variable

Figure C7—ANQP Query Response Field Format

The Info ID field is set to 56797, which is the value corresponding to the Access Network Query Protocol (ANQP) vendor-specific list.

The Length is a 2-octet field whose value is equal to 3 plus the number of octets in the Vendor-Specific content field.

The Status Code values are defined in Table 9-50 of IEEE 802.11-2020 [1].

The OI field shall be equal to 0x50 6F 9A (Wi-Fi Alliance OUI).

Figure C8 illustrates the Vendor-specific content field of the ANQP Query Response Frame.

ANQP Query Response Vendor-specific Content Field						
OUI Subtype	Service Update Indicator	ANQP Query Response Vendor-Specific Content TLV				
		Length	Service Protocol Type	Service Transaction ID	Status Code	Response Data
9	See below	Length	Table 78	Transaction ID	Table 80	See below
1 octet	2 octets	2 octets	1 octet	1 octet	1 octet	variable

Figure C8—ANQP Query Response Frame Vendor-specific Content Field

The OUI Subtype is a 1-octet field and is set to 9.

The Service Update Indicator is a counter that is incremented when a change has occurred in the service information of the P2P Device sending this Query Response frame. See Section 3.1.3.2.

The Length is a 2-octet field whose value is equal to 3 plus the number of octets in the Response Data field.

The Service Protocol Type is a 1-octet field set to the corresponding value in Table 78.

The Service Transaction ID is a 1-octet field set to the corresponding Service Transaction ID in the Service TLV.

The Status Code is a 1-octet field set to the corresponding value in Table 80.

The Response Data is a variable container based on the requested Service Protocol Type.

The Length, Service Protocol Type, Service Transaction ID, Status Code and Response Data fields form a TLV structure. There may one or more such TLV structures in the Vendor-specific Content field of the ANQP Query Response frame.

C.3 GAS Fragmentation

If the GAS Query Response is too large to fit in a single MMPDU, the GAS Fragmentation procedure shall be used. The GAS Fragmentation procedure uses the GAS Comeback Request and GAS Comeback Response frame exchange as defined in IEEE 802.11-2020 [1]. This section defines the GAS Comeback Request and Response frames.

The format of the GAS Comeback Request frame is defined in IEEE 802.11-2020 [1]. This section defines the values that should be used for this frame. Figure C9 illustrates the GAS Comeback Request and its fields.



GAS Comeback Request Frame		
Category	Action	Dialog Token
4	12	Token ID
1 octet	1 octet	1 octet

Figure C9—GAS Comeback Request Frame Format

The Category field is set to a value of 4, indicating Public Action Frame.

The Action field is set to a value of 12 for a GAS Comeback Request.

The Dialog Token is obtained from the corresponding GAS Initial Request Frame.

The format of the GAS Comeback Response frame is defined in IEEE 802.11-2020 [1]. This section defines the values that should be used for this frame. Figure C10 illustrates the GAS Comeback Response Frame Format and its fields.

GAS Comeback Response Frame								
Category	Action	Dialog Token	Status Code	GAS Query Response Fragment ID	GAS Comeback Delay	Advertisement Protocol IE	Query Response Length	Query Response
4	13	Token ID	Table 7-23	See below	See below	See below	Length	See below
1 octet	1 octet	1 octet	2 octets	1 octet	2 octets	variable	2 octets	variable

Figure C10—GAS Comeback Response Frame Format

The Category field is set to a value of 4 indicating Public Action Frame.

The Action field is set to a value of 13 for a GAS Comeback Response Frame.

The Dialog Token is copied from the corresponding GAS Initial Request Action frame.

The Status Code values are defined in Table 9-50 of IEEE 802.11-2020 [1].

The GAS Query Response Fragment ID is used by a responding P2P Device to indicate when GAS fragmentation is being used. A P2P Device responding to a GAS request uses this field to inform the requesting P2P Device/Client of the GAS fragment number of the transmitted frames as well as identifying the last GAS fragment of the Query Response. The first 7 bits (B0-B6) represent the GAS Query Response Fragment ID and the last bit (B7) represents the More GAS Fragments bit. The GAS Query Response Fragment ID is set to 0 for the initial fragment and increments by 1 for each subsequent Comeback Response

in the fragmented Query Response. The More GAS Fragments field is set to 0 for the final GAS fragment in the fragmented response.

The GAS Comeback Delay field is set to a value of 0.

Figure C11 illustrates the Advertisement Protocol IE subfield.

Advertisement Protocol Information Element				
Element ID	Length	Advertisement Protocol Tuple		
108	Length	Query Response Length Limit	PAME-BI	Advertisement Protocol ID
		1111111	0	0
1 octet	1 octet	7 bits	1 bit	1 octet

Figure C11—Advertisement Protocol IE

The Advertisement Protocol Information Element (IE) is defined in Section 9.4.2.92 in IEEE 802.11-2020 [1]. The Advertisement Protocol element includes exactly one Advertisement Protocol ID where the Element ID field is set to 108 (refer to Section 9.4.2 in IEEE 802.11-2020 [1]). The Length is a one-octet field whose value is equal to 2.

The Advertisement Protocol Tuple is defined in Figure 9-486 in IEEE 802.11-2020 [1]. The Query Response Length Limit shall be set to 127 (bits 0 – 6). The Pre-Associated Message Exchange BSSID Independent (PAME-BI) bit shall be set to 0 (bit 7). The Advertisement Protocol ID field shall be equal to 0, Access Network Query Protocol (ANQP).

The Query Response Length field is the total number of octets in the Query Response field.

The Query Response field is a variable container that contains either a complete, or if the response is fragmented, a partial ANQP Query Response field. The ANQP Query Response field is as defined in Figure C7.

Figure C12 illustrates an example GAS Fragmentation frame exchange sequence. In this example, the fragmented response consists of two TLVs (labeled TLV 1 and TLV 2 in the sequence), with fragmentation of the first TLV (TLV 1). Note the duplication of the following fields in each GAS Comeback Response: Dialog Token, Status Code, GAS Query Response Fragment ID (with incrementing value), GAS Comeback Delay, Advertisement Protocol IE and Query Response Length (with an appropriate value for the response).

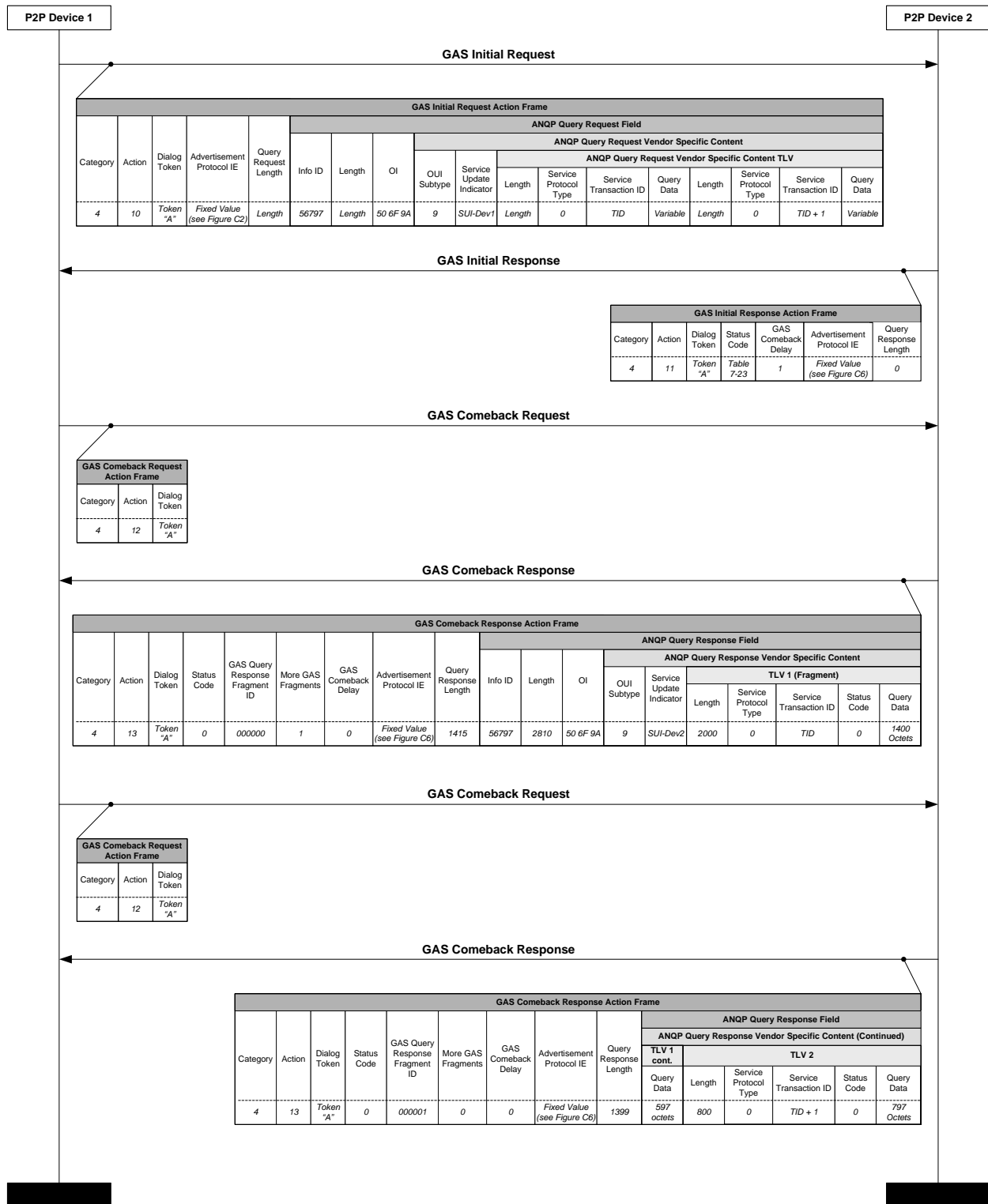

Figure C12—Example GAS Fragmentation Frame Exchange Sequence

Appendix D P2P Discovery Diagrams

This Appendix is for informational purposes. It contains a number of message sequence diagrams that are intended to illustrate possible uses of the P2P Discovery protocol in various example scenarios. No attempt made to cover all possible scenarios or protocol uses and for clarity, the diagrams omit many parameters from the exchanged messages.

The diagrams for scenarios 1a and 1b illustrate the discovery sequence when operating both outside and within DMG.

In all other discovery diagrams described herewith, the following remarks apply when the discovery takes place within DMG:

- Message exchanges related to the DMG beamforming procedure are omitted.
- Authentication frames are not transmitted.
- The term “beacon” or “Beacon” refers to the DMG Beacon frame.



Scenario 1a within DMG: Two P2P Devices discovering each other; group formation occurs on Listen Channel of P2P Device 1

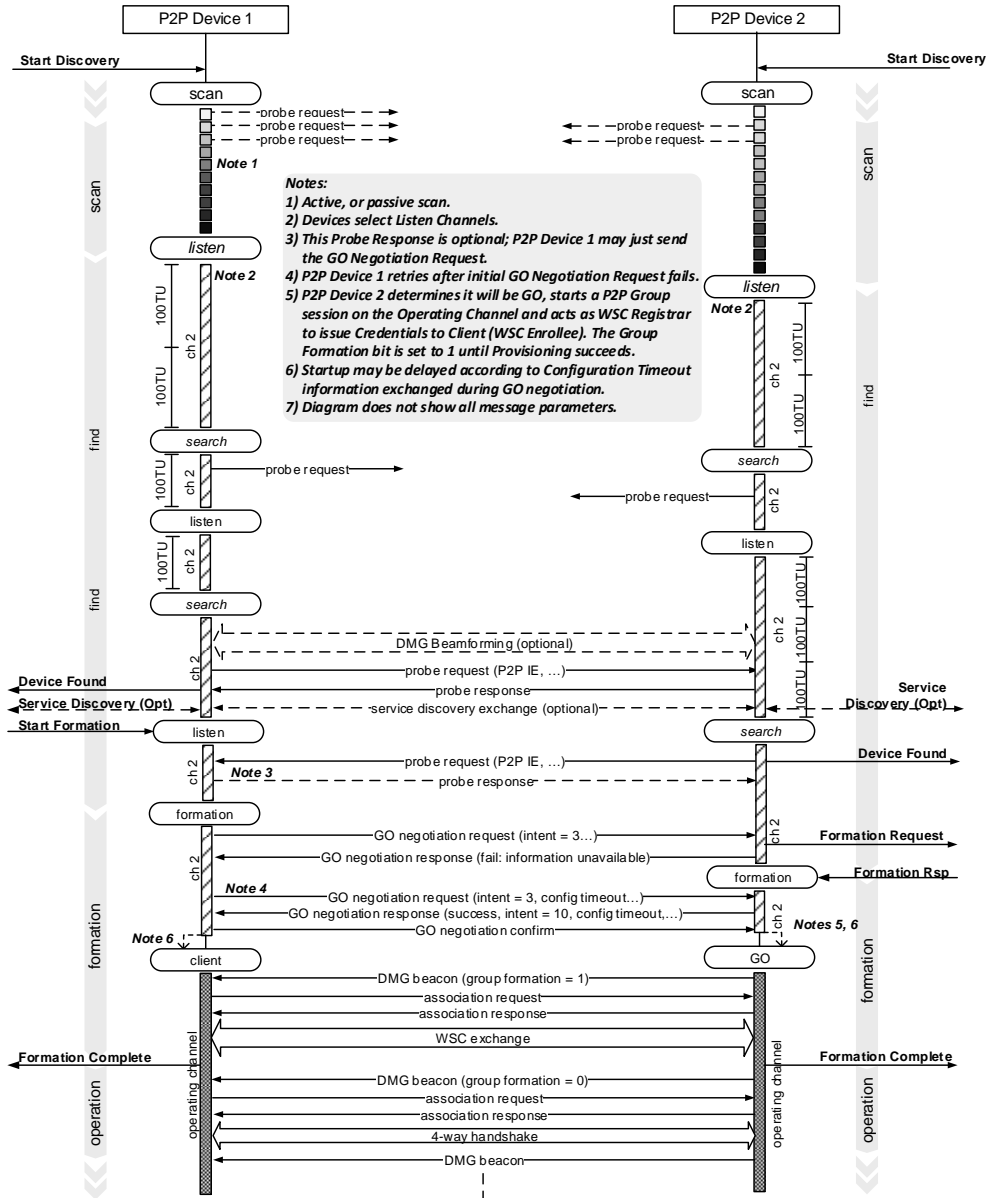



Scenario 1b: Two P2P Devices discovering each other; group formation occurs on Listen Channel of P2P Device 2

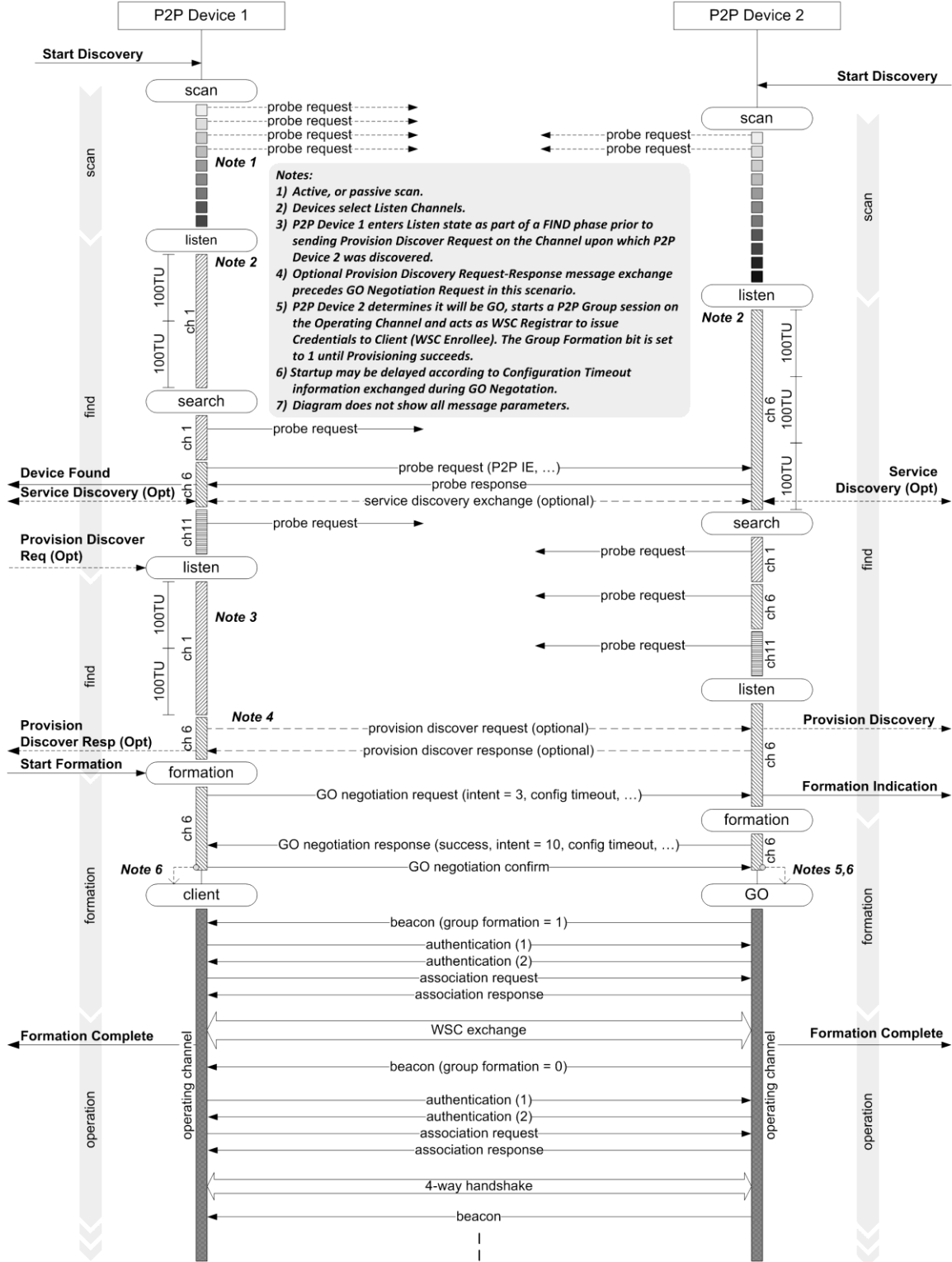



Scenario 1b within DMG: Two P2P Devices discovering each other; group formation occurs on Listen Channel of P2P Device 2

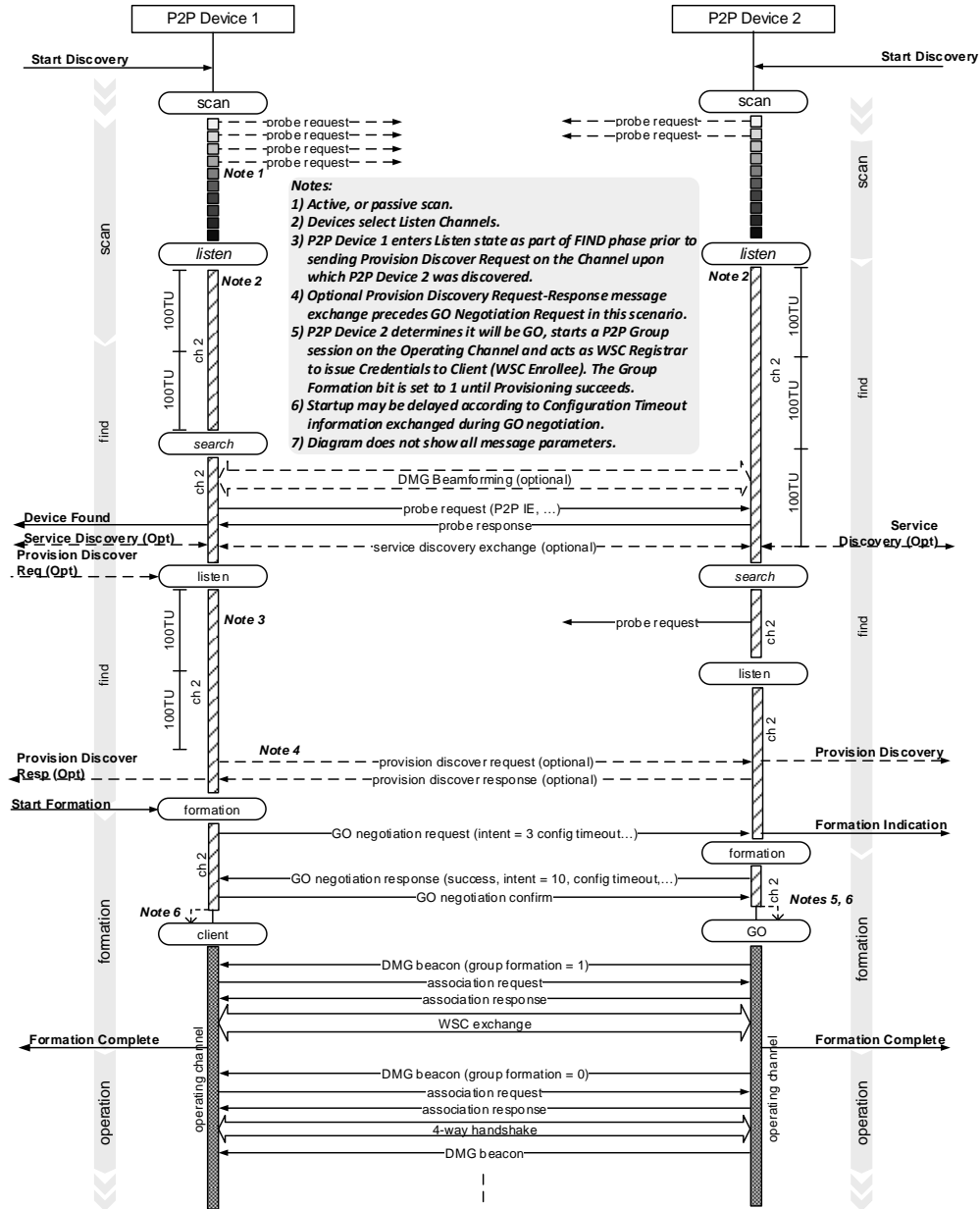



Scenario 2: P2P Device discovering an operational P2P Group

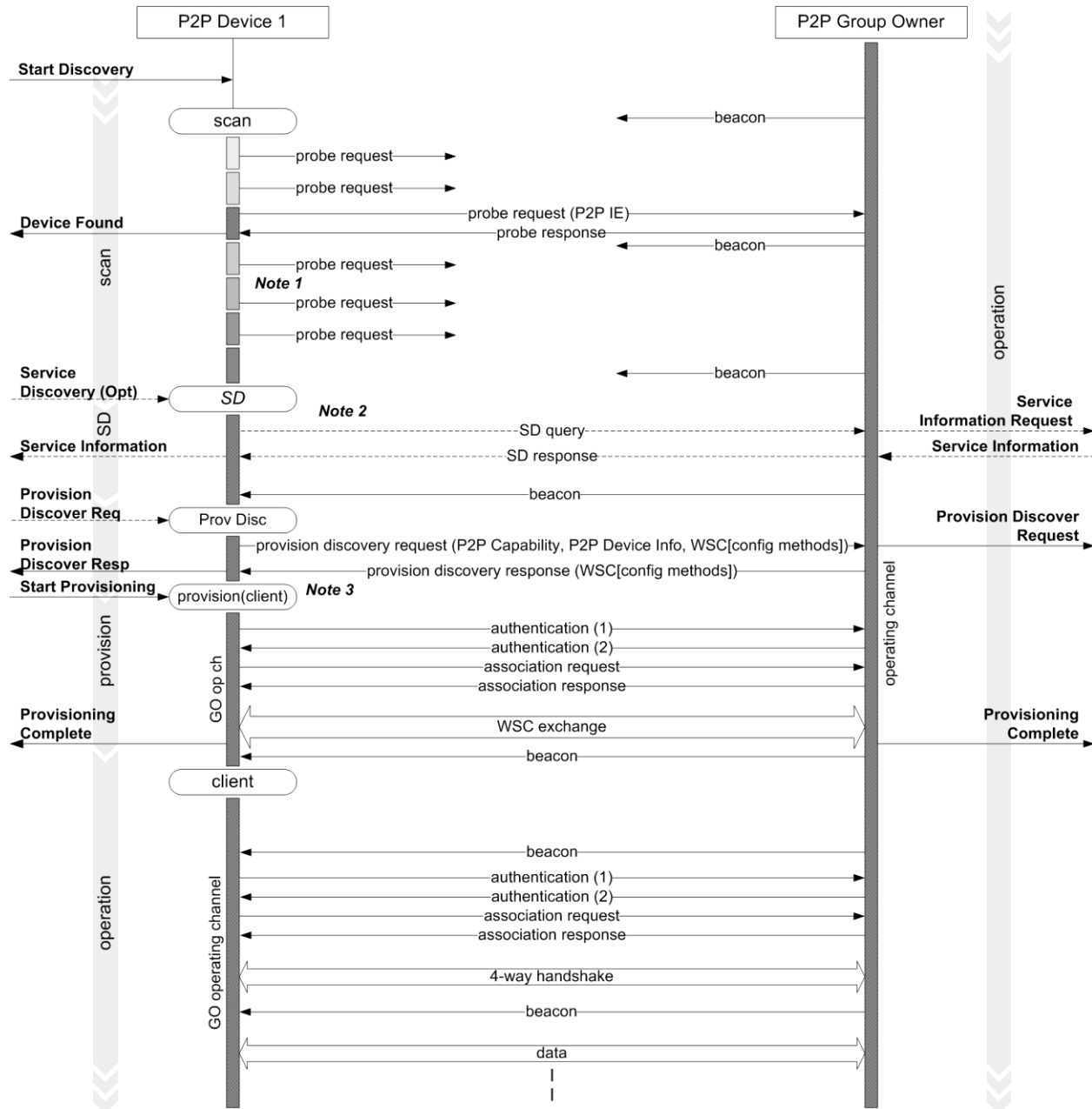

Notes:

- 1) Active, or passive scan.
- 2) Support of Service Discovery (SD) is optional.
- 3) When a P2P Device joins an existing P2P Group it shall send a Provision Discovery Request frame so as to indicate the desire to enroll in the network.
- 4) Diagram does not show all message parameters.



Scenario 3: P2P Device discovering a P2P Device that is the Group Owner of a Persistent P2P Group in Listen State & reinvoking the Persistent Group

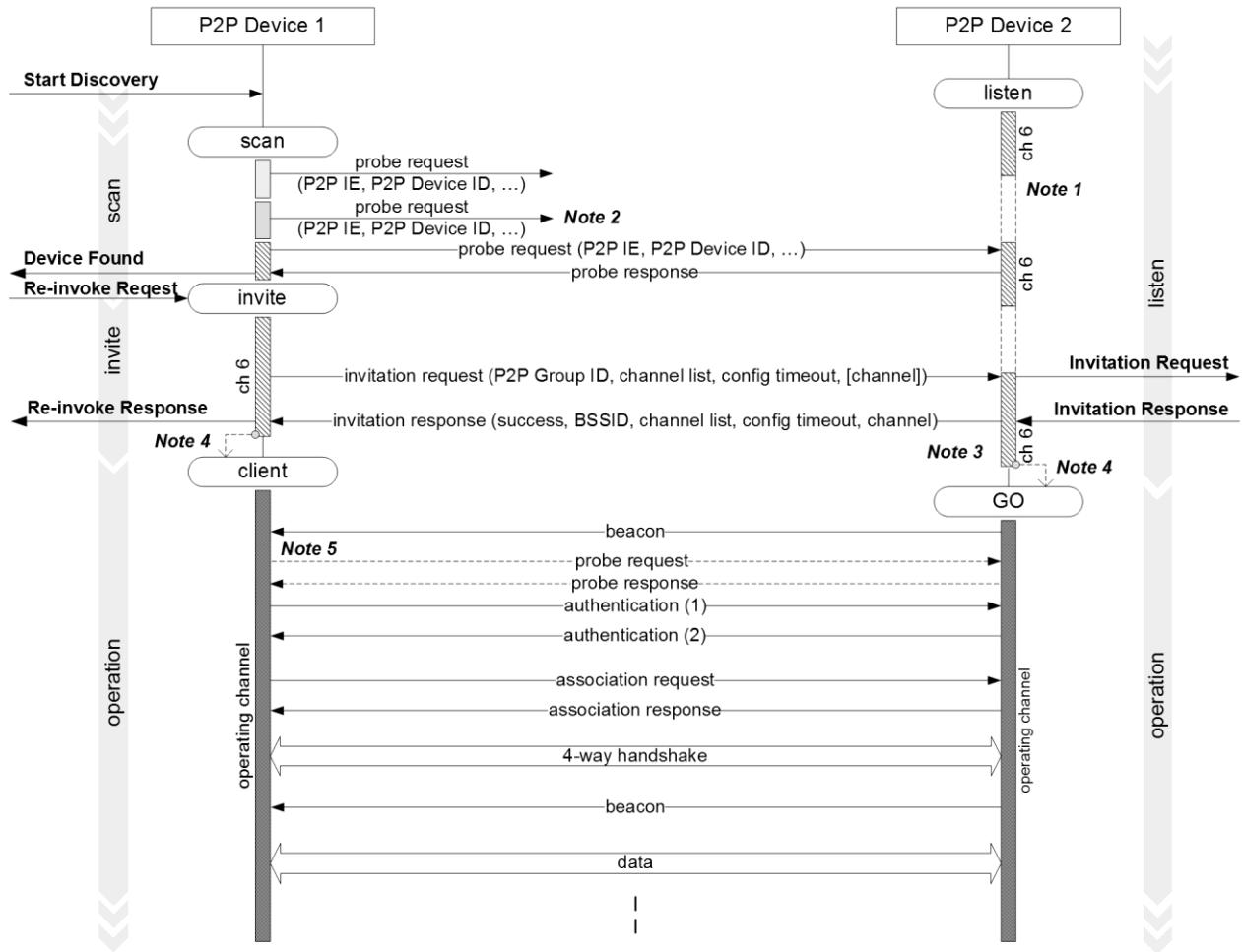

- Notes:**
- 1) Device availability in extended listen subject to recommendations and extended listen timing in Specification.
 - 2) Probe Request to P2P Device that is the GO of the Persistent P2P Group that is being sought could either be sent directly to the Device Address, or contain the P2P Device ID.
 - 3) In this example, P2P Device 1 is a Client in the Persistent P2P Group and requests P2P Device 2 to re-invoke the Group as P2P Group Owner. It would also be possible for P2P Device 1 to be the Group Owner of the Persistent P2P Group and invite P2P Device 2 to join as a P2P Client of that Persistent Group.
 - 4) Startup may be delayed according to Configuration Timeout information exchanged during invitation.
 - 5) Device may scan to verify GO is on expected operating channel.
 - 6) Diagram does not show all message parameters.



Notes:

- 1) P2P Client indicates discoverability in association request.
- 2) P2P GO using opportunistic PS in this example – wakes for CTWindow.
- 3) Searching device includes the Device ID in the Probe Request to elicit a probe Response only from the device it knows to be Go of the Persistent Group it wishes to re-invoke.
- 4) Searching P2P Device may send Device Discoverability Request immediately after receiving Probe Response from P2P GO, though in this example it waits until the next CTWindow.
- 5) Successful delivery of Device Discoverability Request triggers Device Discoverability Response to searching device.
- 6) In this example, P2P Device is a Client in the Persistent P2P Group and requests P2P Client to re-invoke the Group as P2P Group Owner. It would also be possible for P2P Device to be the Group Owner of the Persistent P2P Group and invite P2P Client to join as a P2P Client of that Persistent Group.
- 7) Startup may be delayed according to Configuration Timeout information exchanged during invitation.
- 8) In this scenario, P2P Client is capable of acting as a P2P Client in the existing P2P Group and also as P2P GO for new group (both P2P Groups on the same channel in this example). Alternatively, P2P Client could disconnect from the existing P2P Group and just join the new P2P Group.
- 9) Device may scan to verify GO is on expected operating channel.
- 10) Diagram does not show all message parameters.

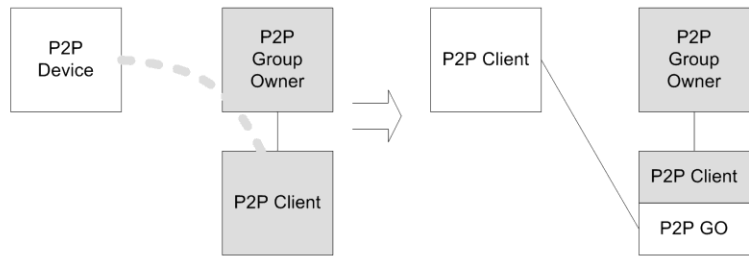

Scenario 4: P2P Device discovering a P2P Device that is the Client in an existing P2P Group and requesting device to reinvok a Persistent P2P Group

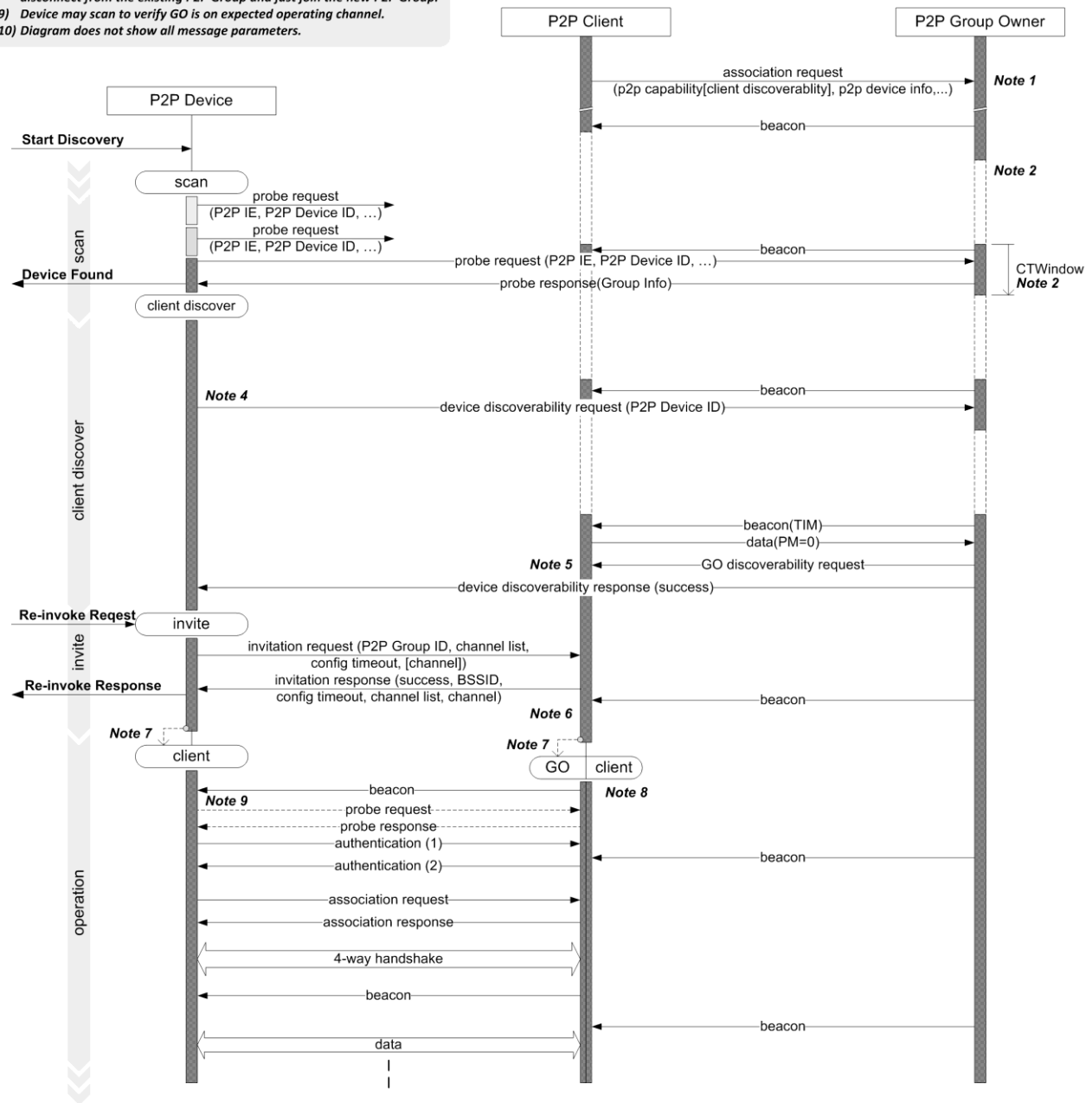



Scenario 5: P2P Device that is Group owner invites P2P Device to join P2P Group

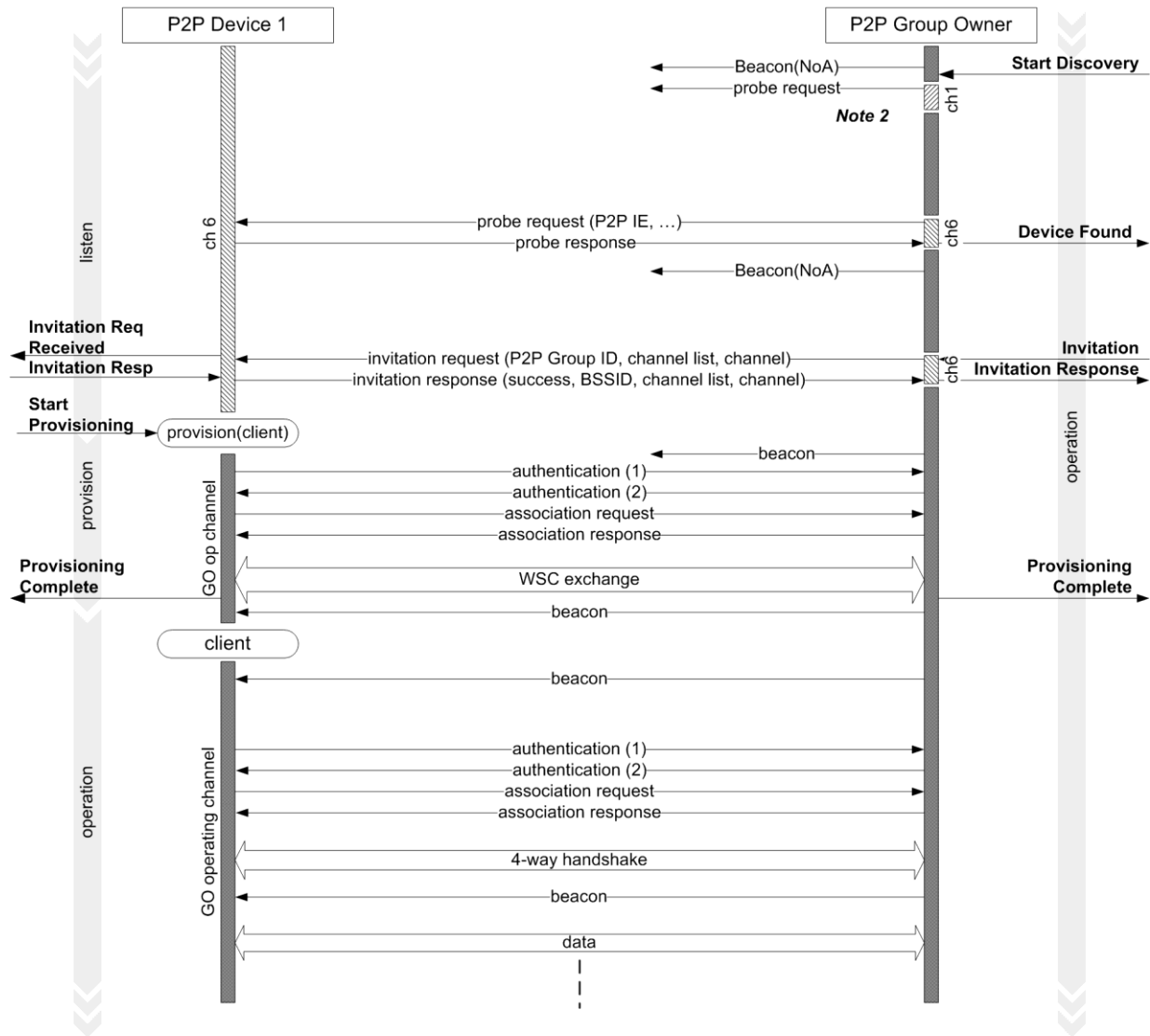

Notes:
 1) Diagram does not show all message parameters.
 2) NoA can be used to signal GO absence.



Scenario 6: Legacy Client discovering and joining an operational P2P Group

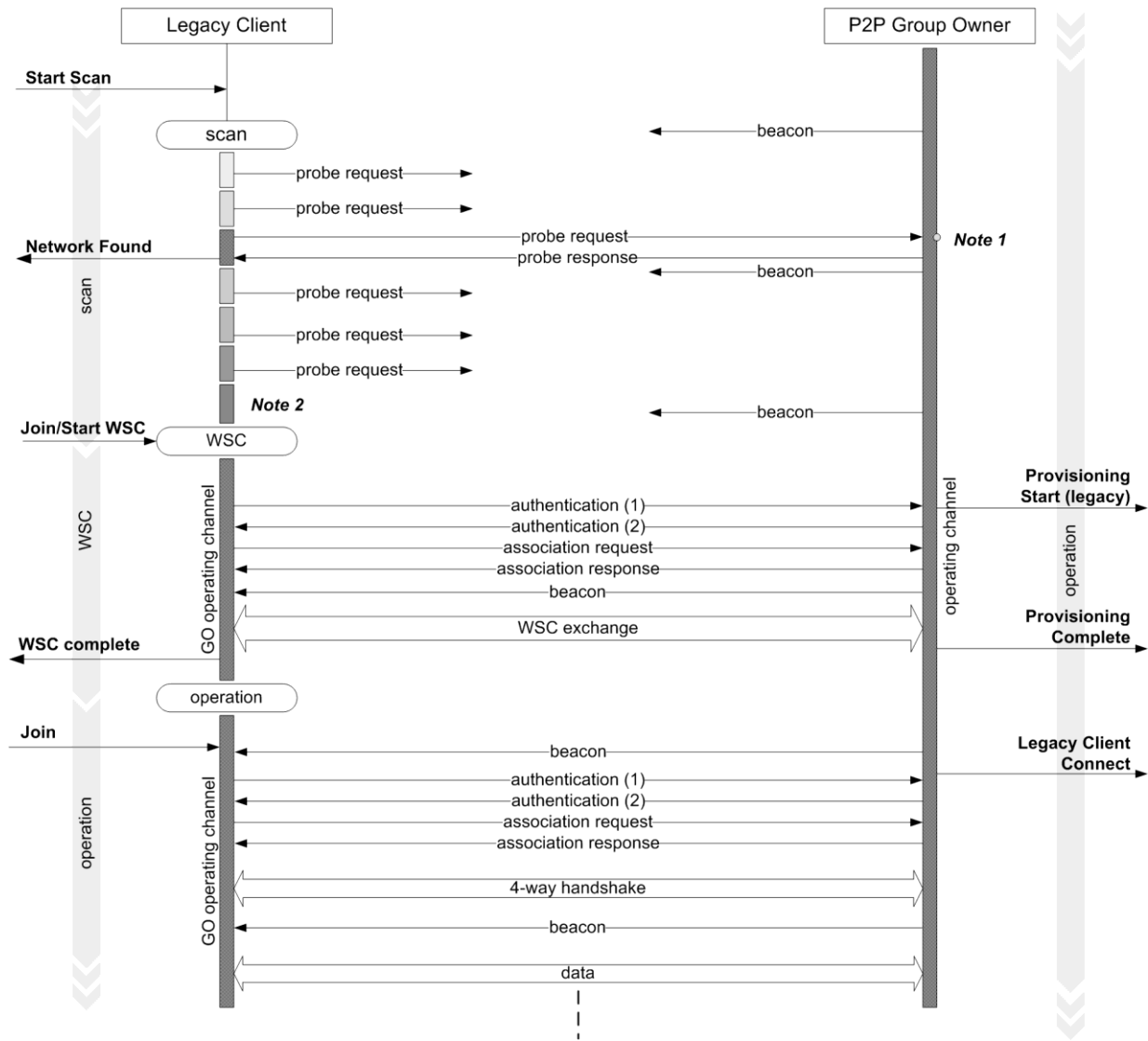

Notes:
 1) P2P Group Owner determines that scanning Device is a Legacy Client from Probe Request; Group Owner does not include P2P Group Info in Probe Response.
 2) Active, or passive scan.
 3) Diagram does not show all message parameters.

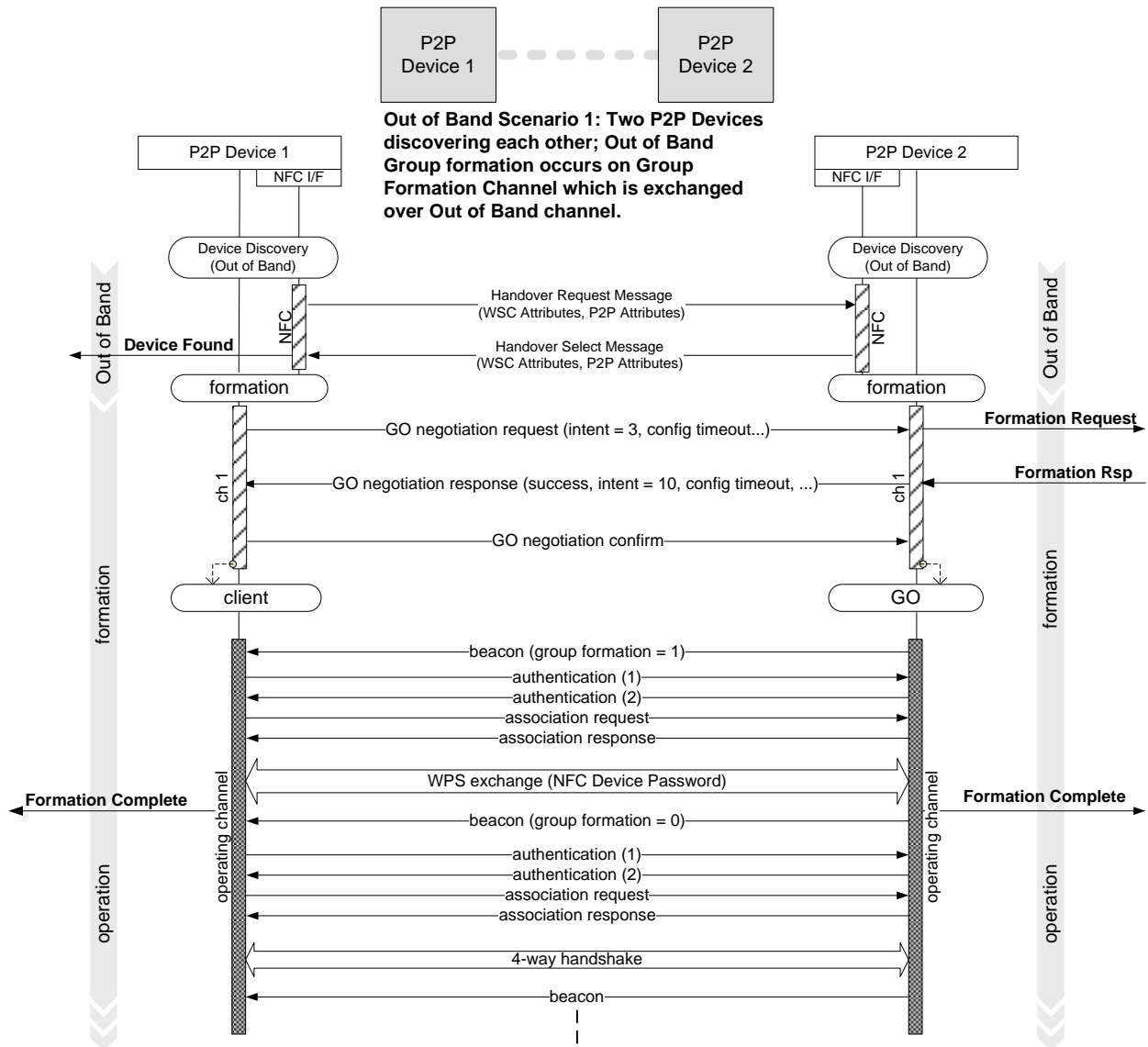

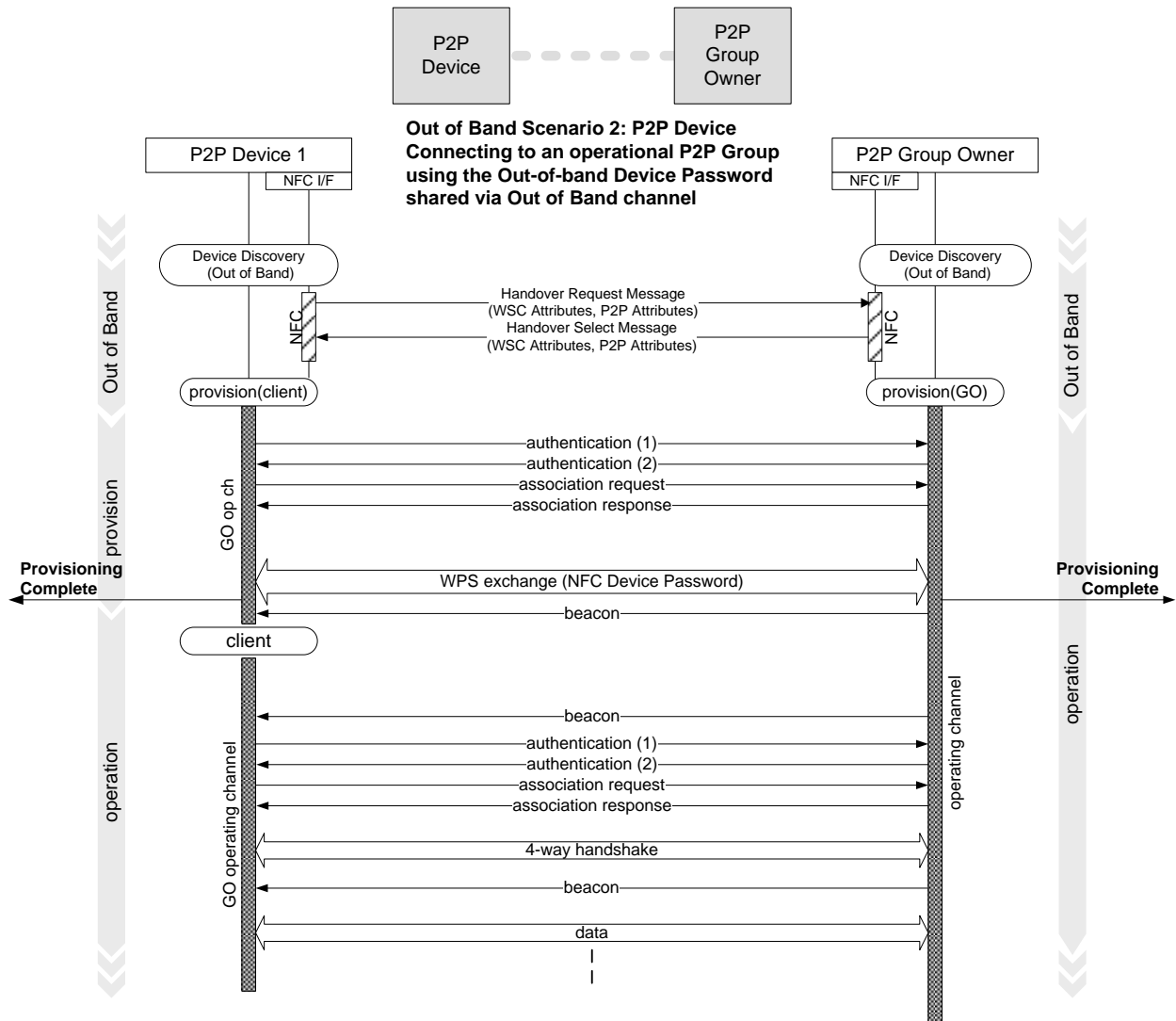

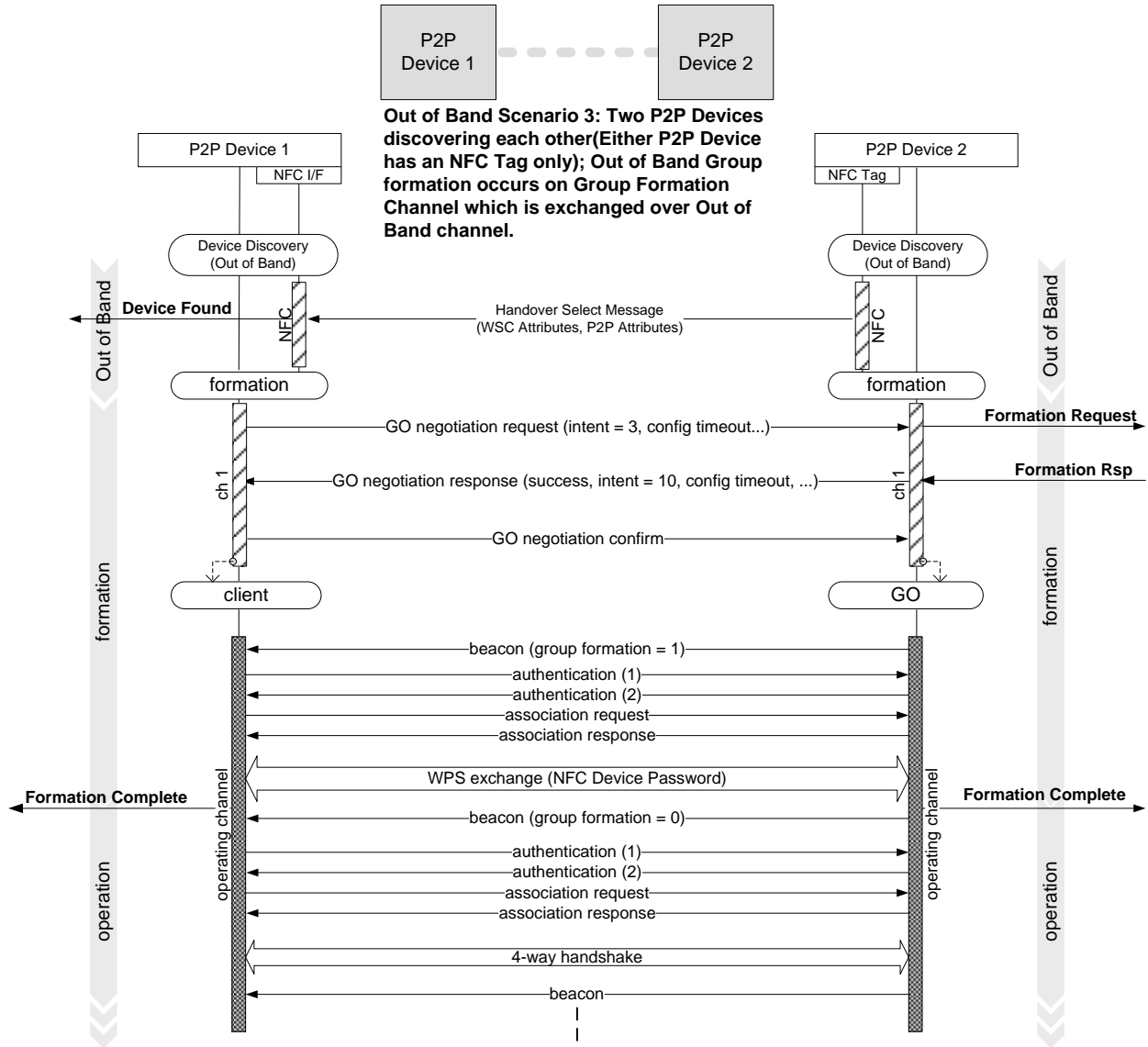

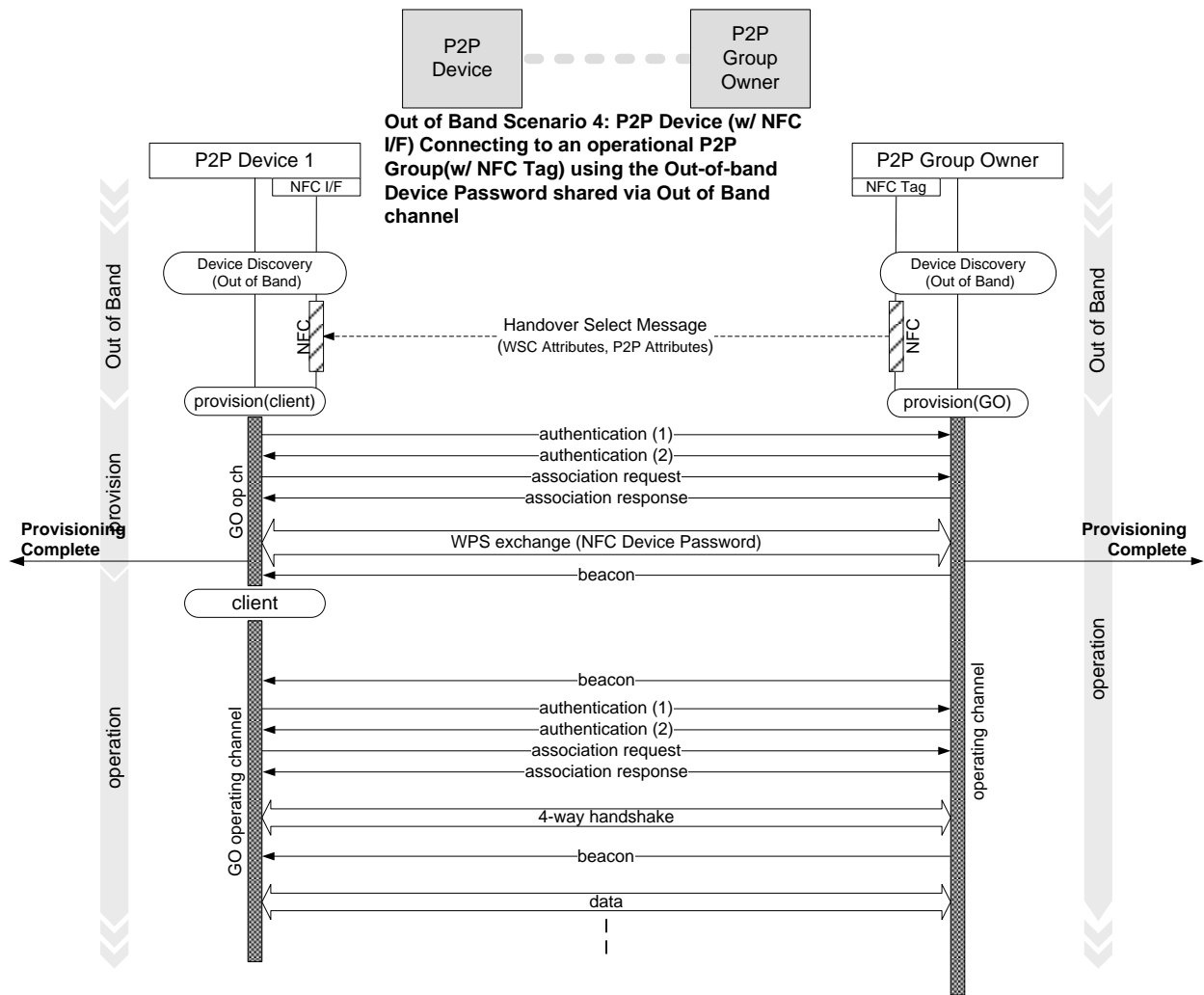

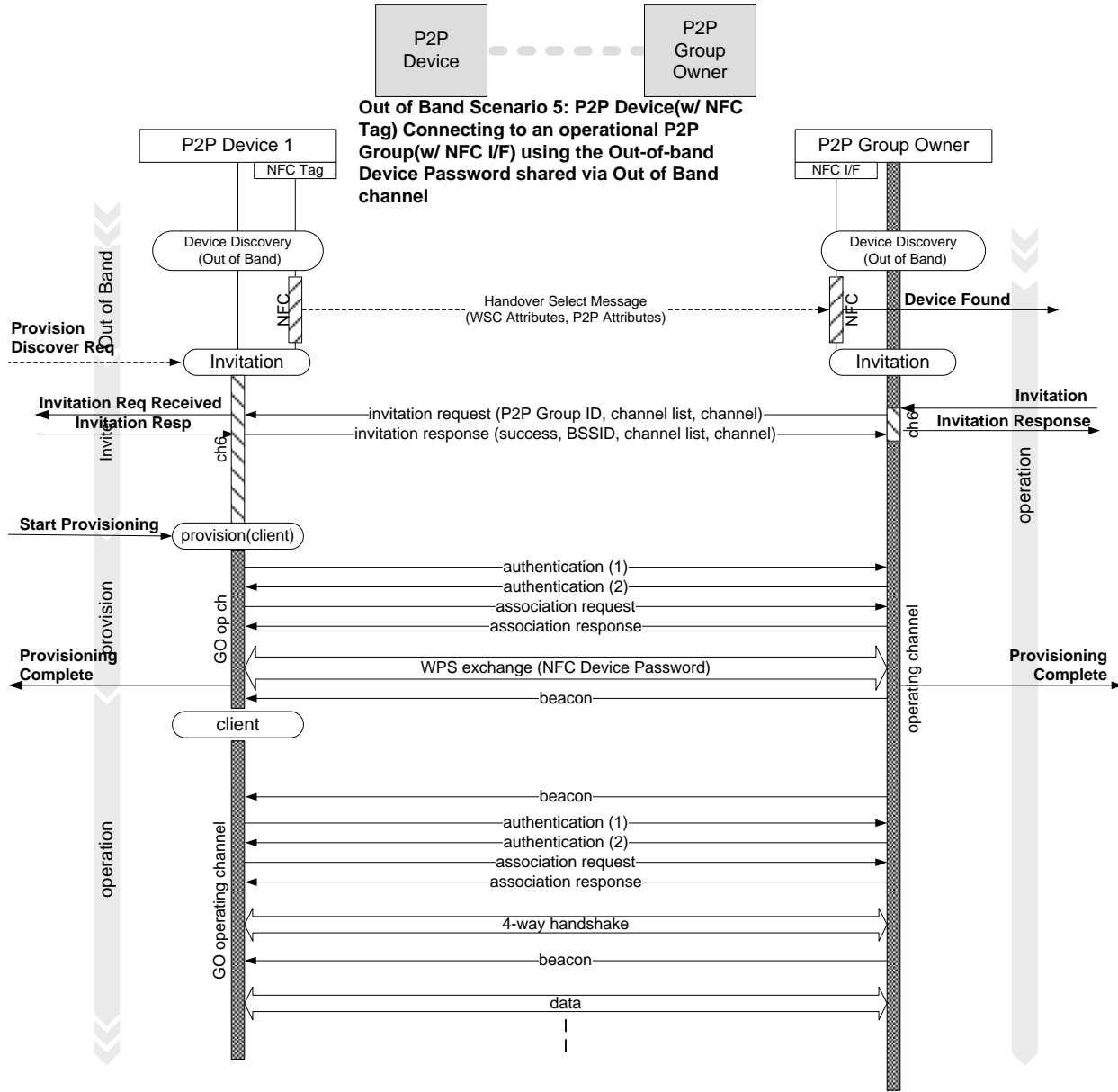

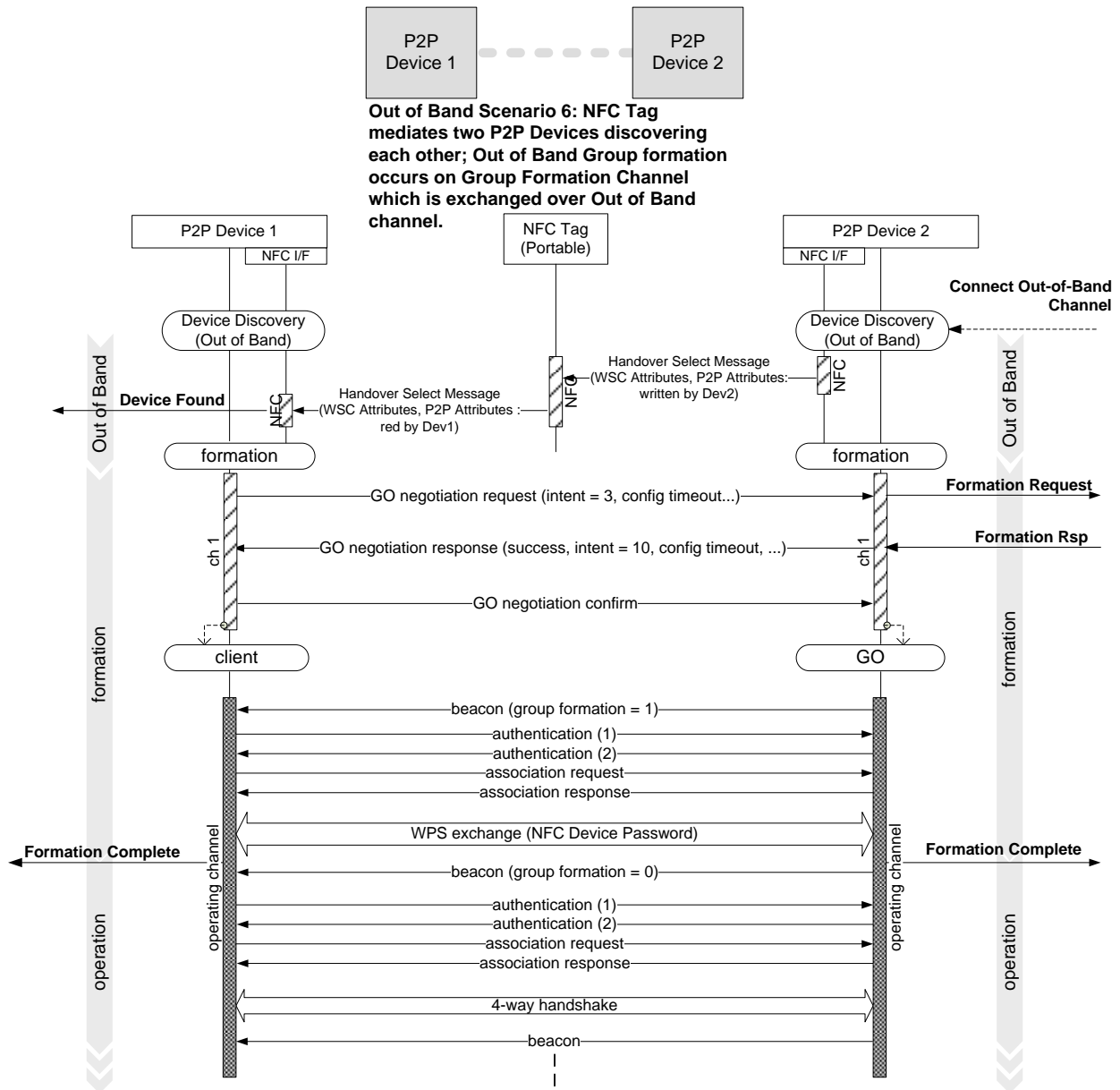

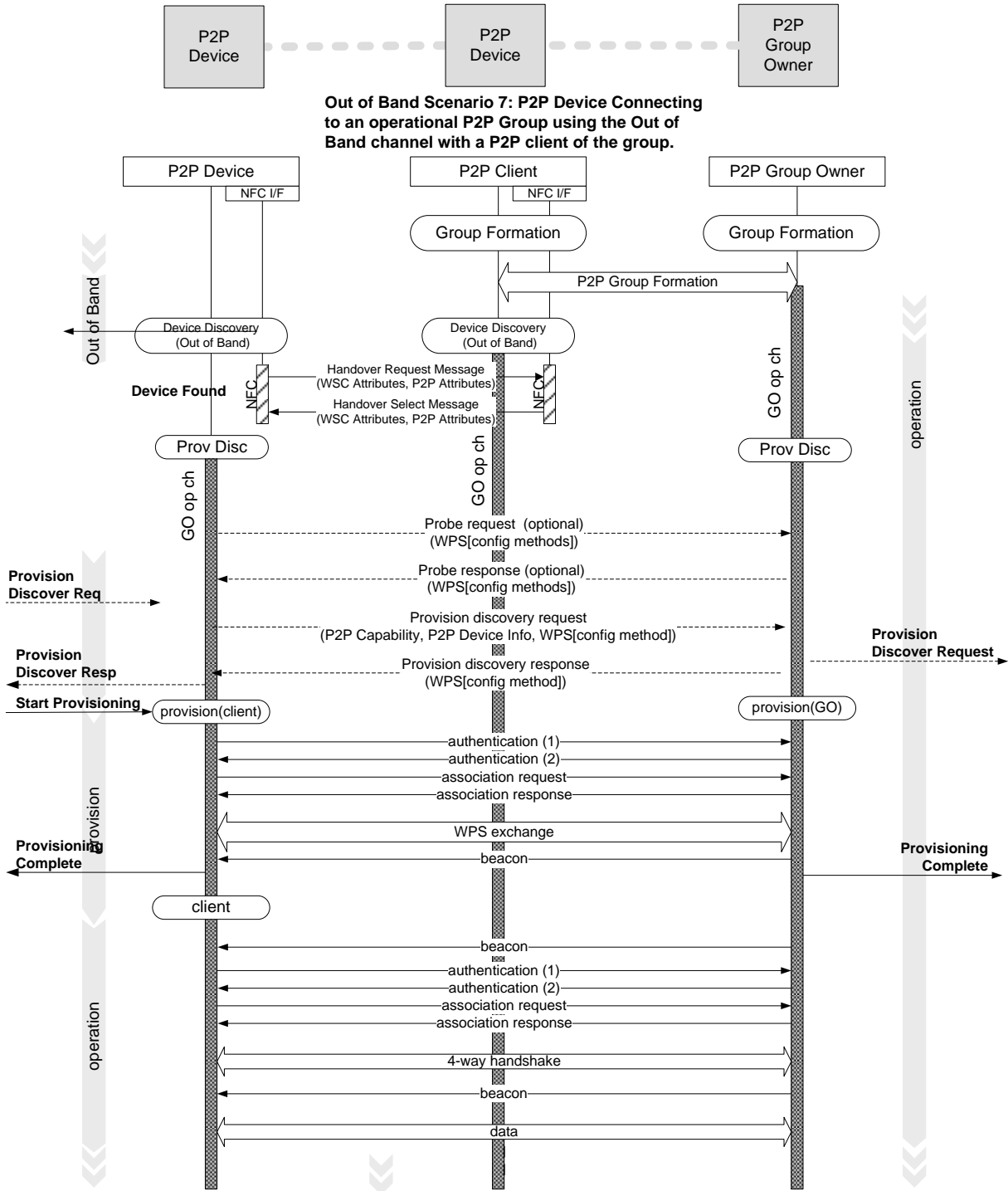

Appendix E Recommended Practices for Bonjour using P2P Service Discovery

The following section provides recommended practices for using Bonjour and DNS-SD using the service discovery mechanism defined in this specification. In addition, some service discovery examples are provided for Apple File Sharing (AFP) and IP Printing (IPP) Bonjour services.

The Service TLV in the ANQP Query Request frame is illustrated in Figure E1 below.

ANQP Vendor-specific Content					
OUI Subtype	Service Update Indicator	Length	Service Protocol Type	Service Transaction ID	Query Data
9	See below	Length	1	Transaction ID	See below
1 octet	2 octets	2 octets	1 octet	1 octet	variable

Figure E1—Query Request Vendor-specific Content

The OUI Subtype shall be set to 9.

The Service Update Indicator is a counter that is incremented when a change has occurred in the service information of the P2P Device sending this Query Request frame. See Section 3.1.3.1.

The Length is equal to 2 plus the number of octets in the Query Data field.

The Service Protocol Type is set to 1 (Bonjour).

The Service Transaction ID is a 1-octet field.

The Query Data variable container for the Bonjour service protocol is illustrated in Figure E2.

Query Data		
DNS Name	DNS Type	Version
Refer to example	Refer to example	Refer to example
variable	2 octets	1 octet

Figure E2—Bonjour Query Data

The Query Data container is divided into 3 fields as illustrated in Figure E2. The complete Query Data is referred to as the key.



The Service TLV in the ANQP Query Response frame is illustrated in Figure E3 below.

ANQP Vendor-specific Content						
OUI Subtype	Service Update Indicator	Length	Service Protocol Type	Service Transaction ID	Status Code	Response Data
9	See below	Length	1	Transaction ID	Table 80	See below
1 octet	2 octets	2 octets	1 octet	1 octet	1 octet	variable

Figure E3—Query Response Vendor-specific Content

The OUI Subtype is set to 9.

The Service Update Indicator is a counter that is incremented when a change has occurred in the service information of the P2P Device sending this Query Response frame. See Section 3.1.3.2.

The Length is equal to 3 plus the number of octets in the Response Data field.

The Service Protocol Type is set to 1 (Bonjour)

The Service Transaction ID is a 1-octet field set to the corresponding Service Transaction ID in the Service TLV.

The Status Code is set to the corresponding value in Table 80.

The Response Data variable container for the Bonjour service protocol is illustrated in Figure E4.

Response Data			
DNS Name	DNS Type	Version	RDATA
Refer to example	Refer to example	Refer to example	Refer to example
variable	2 octets	1 octet	variable

Figure E4—Response Data

The Response Data contains the same fields as the Query Data plus the Record Data (RDATA) as illustrated in Figure E4. The RDATA is referred to as the value. Therefore, the query contains the key and the response contains the key and value pair. The content of the Query Data and Response Data fields shall use DNS name compressions as defined in Section E.3.

The DNS Type shall be set to one of the defined DNS record types as used by DNS Service Discovery (DNS-SD). For information on DNS record types refer to <http://www.iana.org/assignments/dns-parameters/dns-parameters.xhtml>. Pointer (PTR) and Text (TXT) service record types are defined in

<http://tools.ietf.org/html/rfc1035> with usage information in <http://www.dns-sd.org/>. Byte ordering within the DNS Type field shall be big-endian.

The Version field shall be set to 0x01.

If the request is for all services, i.e. the Query Data field in the ANQP Query Request frame has a length of 0, the responding P2P Device shall include in the ANQP Query Response frame (or series of GAS Comeback Response frames as necessary) a TLV for every RDATA record it is advertising.

Other useful links and references:

- <http://www.zeroconf.org/Rendezvous/txtrecords.html>
- <http://tools.ietf.org/html/rfc1035>
- <http://tools.ietf.org/html/rfc4343>
- <http://www.dns-sd.org/>
- <http://www.dns.net/dnsrd/rr.html>
- <http://www.multicastdns.org/>
- <http://www.iana.org/assignments/dns-parameters>

E.1 Example for Apple File Sharing over TCP

In this example, the DNS-SD service type is Apple File Sharing (AFP) over TCP which is `_afpovertcp._tcp.local`. The DNS-SD record type is PTR. The Version is 1.

The human readable DNS Service Type is `_afpovertcp._tcp.local`.

The DNS Record Type is PTR (12d, 0x000C).

The Version is 1 (1d, 0x01).

The complete human readable Query Data (key) is illustrated in Figure E5 below.

Query Data (Key)		
Human Readable DNS Name	DNS Type	Version
<code>_afpovertcp._tcp.local</code>	12 (PTR)	1
variable	2 octets	1 octet

Figure E5—AFP Over TCP Query Data (human readable)

The encoded Query Data using DNS name compression is provided in Figure E6.



Query Data (Key)		
Encoded and Compressed DNS Name	DNS Type	Version
0B 5F 61 66 70 6F 76 65 72 74 63 70 C0 0C	00 0C	01
variable	2 octets	1 octet

Figure E6—AFP Over TCP Query Data (encoded and compressed)

In this example, the DNS-SD service instance name is Example for the AFP over TCP service type. The DNS-SD record type is PTR. The Version is 1.

The human readable DNS service instance and type is Example._afpovertcp._tcp.local.

The DNS Record Type is PTR (12d, 0x000C).

The Version is 1 (1d, 0x01).

The Response Data shall contain the key (Query Data) and value (Response Data) pair. Therefore, the complete human readable Response Data is illustrated in Figure E7.

Response Data (key/value)			
Human Readable DNS Name	DNS Type	Version	RDATA
_afpovertcp._tcp.local.	12 (PTR)	1	Example._afpovertcp._tcp.local.
variable	2 octets	1 octet	variable

Figure E7—AFP over TCP Response Data (human readable)

The encoded Response Data using name compression is illustrated in Figure E8.

Response Data (key/value)			
Encoded and Compressed DNS Name	DNS Type	Version	RDATA
0B 5F 61 66 70 6F 76 65 72 74 63 70 C0 0C	00 0C	01	07 45 78 61 6D 70 6C 65 C0 27
variable	2 octets	1 octet	variable

Figure E8—AFP over TCP Response Data (encoded and compressed)

In this example, there is a text (TXT) record associated to the Example instance of the AFP over TCP service. Text (TXT) records are required for DNS-SD, even if there is only a null byte to show that there is no data for the service.

Therefore, in this example, the human readable text (TXT) record is null.



The DNS Record Type is TXT (16d, 0x0010).

The Version is 1 (1d, 0x01).

The complete human readable Query Data (key) is illustrated in Figure E9 below.

Query Data (Key)		
Human Readable DNS Name	DNS Type	Version
Example._afpovertcp._tcp.local.	16 (TXT)	1
variable	2 octets	1 octet

Figure E9—AFP Over TCP Query Data for Example (human readable)

The encoded Query Data using DNS name compression is illustrated in Figure E10.

Query Data (Key)		
Encoded and Compressed DNS Name	DNS Type	Version
07 65 78 61 6D 70 6C 65 0B 5F 61 66 70 6F 76 65 72 74 63 70 C0 0C	00 10	01
variable	2 octets	1 octet

Figure E10—AFP Over TCP Query Data for Example (encoded and compressed)

The Response Data shall contain the key (Query Data) and value (Response Data) pair. Therefore, the complete human readable Response Data is provided in Figure E11.

Response Data (key/value)			
Human Readable DNS Name	DNS Type	Version	RDATA
Example._afpovertcp._tcp.local.	16 (TXT)	1	null
variable	2 octets	1 octet	variable

Figure E11—AFP over TCP Response Data for Example (human readable)

The encoded Response Data using DNS name compression is illustrated in Figure E12.

Response Data (key/value)			
Encoded and Compressed DNS Name	DNS Type	Version	RDATA
07 65 78 61 6D 70 6C 65 0B 5F 61 66 70 6F 76 65 72 74 63 70 C0 0C	00 10	01	00
variable	2 octets	1 octet	variable

Figure E12—AFP over TCP Response Data for Example (encoded and compressed)

E.2 Example for IP Printing over TCP

In this example, the DNS-SD service type is Internet Printing Protocol over TCP which is `_ipp._tcp.local`. The DNS-SD record type is PTR. The version is 1.

The human readable DNS Service Type is `_ipp._tcp.local`.

The DNS Record Type is PTR (12d, 0x000C).

The Version is 1 (1d, 0x01).

The complete human readable Query Data (key) is illustrated in Figure E13.

Query Data (Key)		
Human Readable DNS Name	DNS Type	Version
<code>_ipp._tcp.local</code> .	12 (PTR)	1
variable	2 octets	1 octet

Figure E13—IPP Over TCP Query Data (human readable)

The encoded Query Data using DNS name compression is illustrated in Figure E14.

Query Data (Key)		
Encoded and Compressed DNS Name	DNS Type	Version
04 5F 69 70 70 C0 0C	00 0C	01
variable	2 octets	1 octet

Figure E14—IPP Over TCP Query Data (encoded and compressed)

In this example, the DNS-SD service instance name is MyPrinter for the IPP over TCP service type. The DNS-SD record type is PTR. The Version is 1.

The human readable DNS service instance and type is `MyPrinter._ipp._tcp.local`.

The DNS Record Type is PTR (12d, 0x000C).



The Version is 1 (1d, 0x01).

The Response Data shall contain the key (Query Data) and value (Response Data) pair. Therefore, the complete human readable Response Data is illustrated in Figure E15.

Response Data (key/value)			
Human Readable DNS Name	DNS Type	Version	RDATA
_ipp._tcp.local.	12 (PTR)	1	MyPrinter._ipp._tcp.local.
variable	2 octets	1 octet	variable

Figure E15—IPP over TCP Response Data (human readable)

The encoded Response Data using name compression is illustrated in Figure E16.

Response Data (key/value)			
Encoded and Compressed DNS Name	DNS Type	Version	RDATA
04 5F 69 70 70 C0 0C	00 0C	01	09 4D 79 50 72 69 6E 74 65 72 C0 27
variable	2 octets	1 octet	variable

Figure E16—IPP over TCP Response Data (encoded and compressed)

In this example, there is a text (TXT) record associated to the MyPrinter instance of the IPP over TCP service.

The human readable text (TXT) record is: txtvers=1, pdl=application/postscript

The DNS Record Type is TXT (16d, 0x0010).

The Version is 1 (1d, 0x01).

The complete human readable Query Data (key) is illustrated in Figure E17 below.



Query Data (Key)		
Human Readable DNS Name	DNS Type	Version
MyPrinter_ipp._tcp.local.	16 (TXT)	1
variable	2 octets	1 octet

Figure E17—IPP Over TCP Query Data for MyPrinter (human readable)

The encoded Query Data using DNS name compression is illustrated in Figure E18.

Query Data (Key)		
Encoded and Compressed DNS Name	DNS Type	Version
09 6D 79 70 72 69 6E 74 65 72 04 5F 69 70 70 C0 0C	00 10	01
variable	2 octets	1 octet

Figure E18—IPP Over TCP Query Data for MyPrinter (encoded and compressed)

The Response Data shall contain the key (Query Data) and value (Response Data) pair. Therefore, the complete human readable Response Data is provided in Figure E19.

Response Data (key/value)			
Human Readable DNS Name	DNS Type	Version	RDATA
MyPrinter_ipp._tcp.local.	16 (TXT)	1	txtvers=1,pdl=application/postscript
variable	2 octets	1 octet	variable

Figure E19—IPP over TCP Response Data for MyPrinter (human readable)

The encoded Response Data using DNS name compression is illustrated in Figure E20 below.



Response Data (key/value)			
Encoded and Compressed DNS Name	DNS Type	Version	RDATA
09 6D 79 70 72 69 6E 74 65 72 04 5F 69 70 70 C0 0C	00 10	01	09 74 78 74 76 65 72 73 3D 31 1A 70 64 6C 3D 61 70 70 6C 69 63 61 74 69 6F 6E 2F 70 6F 73 74 73 63 72 69 70 74
variable	2 octets	1 octet	variable

Figure E20—IPP over TCP Response Data for MyPrinter (encoded and compressed)

E.3 DNS Name Compression

The DNS Name in the Query Data and Response Data are compressed using DNS Name Compression as defined in Section 4.1.4 of RFC 1035.

With traditional DNS Name Compression, the domain name is replaced with a pointer to a prior occurrence of the same name in the DNS query. For P2P SD using GAS, the pointer refers to a virtual in-memory DNS packet with two implied queries (the domain header of the packet is not used for the purposes of compression):

- _tcp.local. PTR IN
- _udp.local. PTR IN

Note that the domain name in the second query is one actual label (_udp) followed by a compression pointer to the second & third labels of the first query (local.). That is, the data of the virtual in-memory DNS packet is (encoded as a C string) as follows.

```
"\x04_tcp\x05local\x00\x00\x0C\x00\x01\x04_udp\xC0\x11\x00\x0C\x00\x01"
```

Again, note that the domain header of the packet is used when calculating compression pointers (offsets from the beginning of the virtual in-memory packet), but otherwise is not used.

The Resource Record (RR, refer to Section 3.2 of RFC 1035) is written starting at byte 27 of the virtual in-memory packet, which is just after the two implied queries. If possible, the RR name is compressed to the queries in the virtual in-memory packet. The two DNS Type bytes are written after the name. The two DNS Class bytes are skipped. If possible and compliant with DNS-SD practice (for example, for SRV and PTR records), the RDATA bytes are also compressed to the RR name and queries in the virtual in-memory packet.

The key is the RR name plus the two bytes of RR Type plus the single Version byte 0x01 (the Version byte is not in the virtual in-memory packet). That is, the RR Class bytes are not included in the key. The value is the RDATA bytes.

For Query Requests (which do not have RDATA), the DNS Name in the Query Data is written starting at byte 27 of the virtual in-memory packet, which is just after the two implied queries. If possible, the RR name is compressed to the



queries in the virtual in-memory packet. The two DNS Type bytes are written after the name. The two DNS Class bytes are unused. DNS names in the key must be canonicalized to lower-case, because DNS names are case-insensitive.

The key is the DNS Name in the Query Data plus the two bytes of RR Type plus the single Version byte 0x01 (the Version byte not in the in-memory packet).

Note, not all service types have compressible RDATA. There are certain DNS service types that are compressible, such as text (TXT) service types. Text (TXT) records are not compressible, since they do not contain a DNS name. The RDATA should only be compressed for those DNS types whose RDATA is compressible per the DNS-SD specification.

E.4 Supported Service Type Hash (SSTH)

The Supported Service Type Hash is a mechanism to improve the efficiency of exchanging service information between P2P devices. The SSTH is a bitwise hash table that contains information about the service types supported by a P2P device. The SSTH has a length of 32 bytes (256 bits). A CRC-8 is computed on the Encoded and Compressed DNS Name of the Query Data (key), which results in a number between 0 – 255. In order to indicate that a service type is supported (advertising a given service), the P2P Device shall set the bit corresponding to that number in the SSTH. For example, a CRC-8 of the compressed name of a given service type (key) results in a value of 201. The 201st bit of the SSTH shall be set to 1 if the service is supported. DNS names in the key must be canonicalized to lower-case, because DNS names are case-insensitive, but the hash for the SSTH is case-sensitive. Therefore, one would get the same hit whether browsing for MyPrinter._ipp._tcp.local. or myprinter._ipp._tcp.local.

If P2P device A queries for the SSTH of P2P device B and only the n-th bit in the SSTH is set, but the service type (key) P2P device A is looking for hashes to the m-th bit (the CRC-8 of the key is m), then P2P device A knows P2P device B does not support the requested service type (key). If the service type (key) hashes to the n-th bit, then P2P device A will have to perform additional SD queries in order to confirm that requested service type (key) is supported and to get additional information (service records) about the requested service type.

The exchange of the SSTH is done using the Service Discovery mechanism (IEEE 802.11-2020 [1]) defined in this Specification.

To request the SSTH from a P2P device, the Service Discovery frame shall include a single Service Request TLV with the Service Protocol Type set to 1 (Bonjour). The Query Data shall contain the DNS Encoded name set to null value (zero length string), the DNS Type set to 0, and the version set to 0.

In response to a Service Discovery query for the SSTH, a single Service Response TLV shall contain the Service Protocol Type set to 1 (Bonjour). The Service Transaction ID is set to the value corresponding to the Service



Transaction ID in the Service Request TLV. If the SSTH is available, the Status Code field is set to Service available (value 0 in Table 64) and the Response Data field shall contain the DNS Encoded Name is set to null value (zero length string), the DNS Type set to 0, the version set to 0, and the RDATA shall contain the corresponding SSTH for the P2P device. If the SSTH is not available, the Status Code field is set to 2 (Requested information not available) and the Response Data field shall contain a DNS Encoded Name set to a null value (zero length string), the DNS Type set to 0, the version set to 0, and the RDATA is set to a null value.



Appendix F Recommended Practices for UPnP using P2P Service Discovery

The following section provides recommended practices for using UPnP/SSDP with the service discovery mechanism defined in this Specification. In addition some UPnP service discovery examples are provided.



Vendor-specific Content in ANQP Query Request					
OUI Subtype	Service Update Indicator	Length	Service Protocol Type	Service Transaction ID	Query Data
0x09	See Section 3.1.3.1	Length	Table 78	Transaction ID	See below
1 octet	2 octets	2 octets	1 octet	1 octet	variable

Figure F1—Vendor-specific Content in ANQP Query Request

Vendor-specific Content in ANQP Query Response						
OUI Subtype	Service Update Indicator	Length	Service Protocol Type	Service Transaction ID	Status Code	Response Data
0x09	See Section 3.1.3.2	Length	Table 78	Transaction ID	Table 80	See below
1 octet	2 octets	2 octets	1 octet	1 octet	1 octet	variable

Figure F2—Vendor-specific content in ANQP Query Response

Query Data	
Query Version	Query Value
NA	NA
1 octet	variable

Figure F3—Query Data

Response Data	
Response Version	Response Value
NA	NA
1 octet	variable

Figure F4—Response Data

Service Protocol Type for UPnP = 2

Query Version should always be set to 0x10 if the query values are compatible with UPnP Device Architecture 1.0. For more information, please refer to: <http://www.upnp.org/specs/arch/UPnP-arch-DeviceArchitecture-v1.0.pdf>. Note that version 1.1 of the UPnP Device Architecture is also compatible with version 1.0.

If Query Version is 0x10, then Query Value must contain the SSDP value of the Search Target (ST:) header of an M-SEARCH discovery request.

Table F1 lists the defined Search Target header values.

Table F1— Query Values

Query Value Syntax	Description
ssdp:all	Searches for all UPnP devices and services
upnp:rootdevice	Searches for all UPnP root devices
uuid: <i>device-uuid</i>	Searches for a particular device
urn:schemas-upnp-org:device: <i>deviceType:ver</i>	Searches for devices of the given type
urn: <i>domain-name</i> :device: <i>deviceType:ver</i>	Searches for devices with a vendor-specific type
urn:schemas-upnp-org:service: <i>serviceType:ver</i>	Searches for devices containing a service of the given type
urn: <i>domain-name</i> :service: <i>serviceType:ver</i>	Searches for devices containing a vendor-specific service

Response Version should always be set to 0x10 if the response values are compatible with UPnP Device Architecture 1.0. For more information, please refer to: <http://www.upnp.org/specs/arch/UPnP-arch-DeviceArchitecture-v1.0.pdf>.

Response Value must contain a comma-separated list of values from the USN: headers of SSDP Discovery Response messages. If no devices matching the Query are found, the Status Code field is set to 2 (Requested information not available) and Response Value must be empty.

The rationale behind returning only the USN: header value is that the complete UPnP discovery should still take place after the IP connection is established. There would be little benefit and a lot of overhead and complexity to duplicate the entire UPnP service discovery stack over Layer 2. The USN: data in the Response Data tells the initiator that a service or UPnP device of interest is present, and it also provides the UUID of the specific device.

The UUID is useful because once the control point device is connected at the IP layer, it can direct its UPnP discovery stack to search for a device with that particular UUID using a minimal value for the SSDP MX: header. Doing this can substantially increase the performance of the UPnP discovery process.

F.1 Example 1—Search for UPnP internet gateway devices



ANQP Query Request for UPnP Internet Gateway devices					
OUI Subtype	Service Update Indicator	Length	Service Protocol Type	Service Transaction ID	Query Data
0x09	1	Length	2 (UPnP)	1	0x10 urn:schemas-upnp-org:device:InternetGatewayDevice:1

Figure F5—Query Request for UPnP Internet Gateway Devices

ANQP Query Response for UPnP Internet Gateway devices						
OUI Subtype	Service Update Indicator	Length	Service Protocol Type	Service Transaction ID	Status Code	Response Data
0x09	1	Length	2 (UPnP)	1	0	0x10 uuid:6859dede-8574-59ab-9332-123456789012::urn:schemas-upnp-org:device:InternetGatewayDevice:1

Figure F6—Query Response for UPnP Internet Gateway Devices

F.2 Example 2—Search for all UPnP root devices

ANQP Query Request for all UPnP root devices					
OUI Subtype	Service Update Indicator	Length	Service Protocol Type	Service Transaction ID	Query Data
0x09	1	Length	2 (UPnP)	2	0x10 upnp:rootdevice

Figure F7—Query Request for all UPnP root devices

ANQP Query Response for all UPnP root devices						
OUI Subtype	Service Update Indicator	Length	Service Protocol Type	Service Transaction ID	Status Code	Response Data
0x09	1	Length	2 (UPnP)	2	0	0x10 uuid:6859dede-8574-59ab-9332-123456789012::upnp:rootdevice, uuid:5566d33e-9774-09ab-4822-333456785632::upnp:rootdevice

Figure F8—Query Response for all UPnP root devices

F.3 Example 3—Search for a specific device by its UUID



ANQP Query Request for a UPnP device by its UUID					
OUI Subtype	Service Update Indicator	Length	Service Protocol Type	Service Transaction ID	Query Data
0x09	1	Length	2 (UPnP)	3	0x10 uuid:6859dede-8574-59ab-9332-123456789012

Figure F9—Query Request for a UPnP device by its UUID

ANQP Query Response for a UPnP device by its UUID						
OUI Subtype	Service Update Indicator	Length	Service Protocol Type	Service Transaction ID	Status Code	Response Data
0x09	1	Length	2 (UPnP)	3	0	0x10 uuid:6859dede-8574-59ab-9332-123456789012

Figure F10—Query Response for a UPnP device by its UUID

F.4 Example 4—Search for all instances of a UPnP Media Server Content Directory Service

ANQP Query Request for all instances of a UPnP Media Server CDS					
OUI Subtype	Service Update Indicator	Length	Service Protocol Type	Service Transaction ID	Query Data
0x09	1	Length	2 (UPnP)	4	0x10 urn:schemas-upnp-org:service:ContentDirectory:2

Figure F11—Query Request for all instances of a UPnP Media Server CDS

ANQP Query Response for all instances of a UPnP Media Server CDS						
OUI Subtype	Service Update Indicator	Length	Service Protocol Type	Service Transaction ID	Status Code	Response Data
0x09	1	Length	2 (UPnP)	4	0	0x10 uuid:1122de4e-8574-59ab-9322-333456789044::urn:schemas-upnp-org:service:ContentDirectory:2,uuid:5566d33e-9774-09ab-4822-333456785632::urn:schemas-upnp-org:service:ContentDirectory:2

Figure F12—Query Response for all instances of a UPnP Media Server CDS

Appendix G Recommended Practices for Peer-to-Peer Services (P2Ps) using P2P Service Discovery

The following section provides recommended practices for using Peer-to-Peer services (P2Ps) [10] with the service discovery mechanism. In addition to existing Service Protocol Types (see Table 78 (Service Protocol Types)) a new type for P2Ps is defined. The search query shall include the exact service name or service name prefix, to find service(s) on remote side. The Service Information Request string may be zero length if it is not applicable. The result of the GAS Request may be up to 64K of application defined data, minus the mandatory overhead of the GAS protocol.

The "Service Protocol Type" field in ANQP Query Request Frame Vendor-specific Content is set to 0x0B.

Table G1 (Query Data format in ANQP Query Request Frame Vendor-Specific Content for P2Ps) illustrates the "Query Data" field format in ANQP Query Request Frame Vendor-specific Content TLV for P2Ps. Refer to Figure C4 (ANQP Query Request Frame Vendor-specific Content).

The "Service Protocol Type" field in ANQP Query Response Frame Vendor-specific Content is set to 0x0B.

Table G2 (Response Data format in ANQP Query Response Vendor-specific Content for P2Ps) illustrates the "Response Data" field format in ANQP Query Response Vendor-specific Content TLV for P2Ps. Refer to Figure C8 (ANQP Query Response Frame Vendor-specific Content Field).

Table G1 - Query Data format in ANQP Query Request Frame Vendor-Specific Content for P2Ps

Field Name	Size (octets)	Value	Description
Service Name Length	1	0x00-0xFF	Length of Service Name
Service Name	Service Name Length	variable	Service name or prefix of the service name being searched for extra information
Service Information Request Length	1	0x00-0xFF	Length of Service Information Request
Service Information Request	variable	variable	UTF-8 substring to search for inside service_information

Table G2 - Response Data format in ANQP Query Response Vendor-specific Content for P2Ps

Field Name	Size (octets)	Value	Description
Number of Service Info Descriptor	1	variable	The number of Service Info Descriptor
Service Info Descriptor(s)	Sum of all Service Info Descriptor(s)		

Table G3 - Service Info Descriptor format

Field Name	Size (octets)	Value	Description
Advertised Service Descriptor	Size of Advertised Service Descriptor		Advertised Service Descriptor in Section 4.1.26 (Advertised Service Info Attribute)
Service Status	1	0x00-0xFF	0x00 – Not Available 0x01 – Available Else – Service Specific
Service Information Length	2	variable	Length of Service Information
Service Information	variable	variable	Application defined service information data.